



# Frame scaffoldings Mostostal Plus



ASSEMBLY MANUAL  
2009

<b>1. Technical overview, general rules of scaffolding assembly and use</b>	<b>page 4</b>
<b>1.1. Characteristic of Mostostal Plus frame scaffoldings</b> .....	4
<b>1.2. Reference documents</b> .....	4
<b>1.3. General rules of scaffolding assembly and storage</b> .....	4
<b>2. Scaffolding assembly up to 34 m high</b>	<b>page 6</b>
<b>2.1. Preliminary actions</b> .....	6
<b>2.2. Assembly guidelines for safer use</b> .....	6
<b>2.2.1. Safety Kit</b> .....	6
<b>2.3. Frame scaffolding assembly steps</b> .....	8
<b>2.4. Assembly rules important from safety point of view</b> .....	10
<b>2.5. Rules for anchoring and assembly of braces</b> .....	16
<b>2.5.1. General anchoring rules</b> .....	16
<b>2.5.2. Assembly rules for angle braces</b> .....	17
<b>2.5.3. Combination of forces in anchorings and footings of typical sets</b> .....	17
<b>2.5.4. Braces and anchors arrangement for non-shielded scaffolding up to 34 m high</b> .....	17
<b>2.5.5. Braces and anchors arrangement for scaffolding shielded with net screen                 or canvas, up to 34 m high</b> .....	26
<b>2.5.6. Additional anchors during girder assembly</b> .....	34
<b>2.5.7. Additional anchors during protective canopy and passage frames installation</b> .....	35
<b>3. Mobile scaffoldings</b>	<b>page 36</b>
<b>4. General requirements and safety rules during scaffolding assembly and use</b>	<b>page 37</b>
<b>5. Exemplary, non-standard scaffolding anchorings</b>	<b>page 41</b>
<b>6. Exemplary frame scaffolding set-ups</b>	<b>page 42</b>
<b>7. Data required to perform structural analysis for scaffoldings</b>	<b>page 43</b>
<b>8. Raw-materials used for elements' construction</b>	<b>page 44</b>
<b>9. Product marking system</b>	<b>page 45</b>
<b>10. Frame scaffoldings component list</b>	<b>page 46</b>
<b>11. Exemplary set – frame scaffolding</b>	<b>page 51</b>
<b>12. Annex 1</b>	<b>page 52</b>

## 1. TECHNICAL OVERVIEW, GENERAL RULES OF SCAFFOLDING ASSEMBLY AND USE

### 1. Technical overview rules of scaffolding assembly and use

#### 1.1. Characteristic of Mostostal Plus frame scaffoldings

Frame scaffoldings are system scaffoldings with longitudinal frame spacing of 3.07 m, 2.57 m, 2.07 m, 1.57 m, 1.09 m and two standard spacings of transverse frame stands measuring 0.73 and 1.09 m. Scaffolding structure allows standard installation of platforms every 2 m vertically. It also allows different level heights with the use of compensating frames or transverse transoms. The system allows very fast and reliable scaffolding of buildings, with the use of brackets and girders, it is possible to construct scaffolding around buildings with complicated shape. The system also permits construction of large size platforms, e.g. scenes, ceiling platforms, etc., as well as supporting and load-bearing structures for different kinds of billboards, racks, camera stations and occasional tribunes placed during cultural-recreational events.

System elements can be used as working and safety platforms, or as a supporting structure for roof girders assembled in covering to protect the building during winter.

These scaffoldings are made for inspection, plastering, painting and thermal insulation works as well as facade cleaning. In 1.09 m option, they can be used for heavy construction works such as: boarding and bricklaying. It can also be utilized for warehousing the materials required to perform the aforementioned works. Steel working platforms are used to construct the scaffolding. Platform's permissible load ranges from 2 kN/m<sup>2</sup> (200 kg/m<sup>2</sup>) up to 6 kN/m<sup>2</sup> (600 kg/m<sup>2</sup>), depending on the length of platforms and aluminium/plywood platforms with permissible load of 2 kN/m<sup>2</sup> (200 kg/m<sup>2</sup>).

Structures made with aforementioned scaffoldings are stable and steady owing to vertical, angle braces and anchoring system that attaches the scaffolding to the building.

**WARNING: The criteria no. K/0812-721/1/08 of the Institute of Mechanised Construction and Rock Mining - Warsaw (Instytut Mechanizacji Budownictwa i Górnictwa Skalnego w Warszawie) differentiates the concept of a board (single element) and a platform (built of boards). In this manual, according to the apprenticeship, the word PLATFORM will be equivocal for both meanings.**

#### 1.2. Reference documents

During the design, assembly, disassembly and general use of the scaffoldings, it is crucial to respect all the norms and regulations mentioned in:

- This manual.
- Regulation of the Minister of Work and Social Policy of 28 August 2003 establishing general rules for occupational safety and health – consolidated text (Journal of Laws No. 169/03, item 1650), as amended.
- Regulation of the Minister of Economy of 30 October 2002 regarding minimal requirements for occupational safety and health as far as the use of machines by workers during working hours (Journal of Laws No. 191/02, item 1596), as amended.
- Regulation of the Minister of Infrastructure of 6 February 2003 regarding occupational safety and health during construction works (Journal of Laws No. 47/03, item 401).
- PN-M-47900-1:1996 “Steel, standing scaffoldings. Definitions, division and main parameters”.
- PN-M-47900-2:1996 “Steel, standing scaffoldings. Pole scaffolding made of pipes”.
- PN-M-47900-3:1996 “Steel, standing scaffoldings. Frame scaffoldings”.
- PN-EN 12811-1:2004 “Provisional structures used at a construction site. Scaffoldings. Conditions for the production and general design rules”.
- PN-EN 12810-1:2004 “Facade scaffolding made of prefabricated elements. Products' technical specifications”.
- PN-EN 12810-2:2004 “Facade scaffolding made of prefabricated elements. Particular design and construction methods”.
- PN-EN 74:2002 “Couplings, centering plungers and foot sets used in working and load-bearing scaffoldings made of steel pipes. Requirements and examination procedures”.
- PN-EN 39:2003 “Steel pipes for scaffolding construction – Technical regulations for the delivery process”.

#### 1.3. General rules of scaffolding assembly and storage

**REMEMBER: Due to the scaffolding work safety, ALWAYS read the Assembly Manual in its entirety.**

Basic Mostostal Plus scaffoldings' technical/exploitation data in standard set-up:

- work load – 2 kN/m<sup>2</sup> (200 kg/m<sup>2</sup>) (nominal scaffolding size 3, according to PN-M-47900-2:1996);
- number of platforms put under load simultaneously – one platform on each vertical section of the scaffolding;
- bay width – 0.73 m or 1.09 m;
- bay length – max. 3.07 m;

#### **WARNING:**

*Assembly manual does not substitute OHS rules at the construction site!  
Construction manager is responsible for proper scaffolding assembly and inspection!*

## 1. TECHNICAL OVERVIEW, GENERAL RULES OF SCAFFOLDING ASSEMBLY AND USE

- scaffolding height (height of top working platform) – 34 m + 0.2 m;
- scaffolding minimal length – 10 m;
- maximum distance from internal stand to wall – 0.56 m (with the use of internal bracket that expands working platform);
- maximum level of adjustable footing unscrewing – 20 cm;
- minimum number of braces per level – 2, distance between braces is less than 10 m.

Typical scaffolding assembly structures are presented in chapter 2. They consist of expansions, protective canopies, passageways under scaffolding, transport outrigger assembly, net screens and protective canvases, etc.

Static proof calculations are not required for typical set-ups.

Static proof calculations must be performed for the following types of scaffoldings:

- used in II, IIa, IIb and III wind zone according to PN-77/B-02011;
- with permissible load not greater than 2 kN/m<sup>2</sup> or the ones, where more than one platform will be placed under load (in each vertical section of the scaffolding);
- assembled differently than typical wall set-up described in this manual;
- with compensating frames (scaffoldings placed on the terrain with considerable slope level).

**1.3.1.** Scaffoldings can be assembled, disassembled and stored only under supervision of properly qualified personnel.

**1.3.2.** Before commencing the assembly, the scaffolding ground base needs to be checked. It has to absorb the loads coming from the weight and vertical forces present on the scaffolding. Load-bearing capability of the ground base, on which the scaffolding has been placed, cannot be lower than 10 MPa. Load-bearing capability is established according to PN-81/B-03020. In case of construction bases and base reinforcement, the scaffolding placement has to meet the requirements of PN-M-47900-2 section 4.4.

**1.3.3.** During scaffolding assembly use plumbing jig, hex 19/22 and 500 g hammer, which is used for wedge attachment.

**1.3.4.** Screw footing should be placed on wooden base perpendicular to the wall. At least two feet should be placed on a single base.

**1.3.5.** For assembly use only undamaged, genuine scaffolding elements made by ALTRAD-Mostostal (type Mostostal Plus). It is possible to use steel pipes according to the PN-EN 39 standard which can be attached to frames' stands with couplings that meet the requirements of the PN-EN 74 standard.

**1.3.6.** Frame scaffolding brace is performed at the external surface of the scaffolding, parallel to the wall's face. Vertical braces should be placed in every fifth bay of the scaffolding net screen, for the bay of 2.57 m, and every fourth for the bay of 3.07 m. At least two braces should be placed counter wise on a single level.

**1.3.7.** It is allowed to expand the scaffolding platform with the use of steel brackets measuring 0.36 m and 0.73 m. Brackets measuring 0.36 m can be mounted at the internal side of the scaffolding (facade side) on each level.

Brackets measuring 0.73 m can be mounted on external side of the scaffolding, on its last level, or on any level with obligatory anchoring of the extension to the wall with mounted bracket, and to one level above and below. Brackets measuring 0.73 m must be supported with diagonal measuring 1.95 m (e285119).

**1.3.8.** Scaffolding transport and assembly

Scaffolding elements are packed at the manufacturer's site. Size and weight of packages are settled according to client's request. Manufacturer offers special pallets used for scaffolding frames transport to the construction site. The pallets allow fast scaffolding elements transportation, without the risk of damage– transport can be performed with forklifts, platform trucks – and cranes. When storing elements at the client's premises, it is important to properly warehouse and secure wooden elements (wooden platforms, curbs) from adverse atmospheric conditions.

**1.3.9.** The criteria for elements repair and scrapping

At the start of the assembly and during disassembly, scaffolding elements must be inspected for further usefulness.

Elements with visible signs of damage cannot be used. It is particularly important not to use:

- elements with signs of corrosion localized at the connection areas (welds),
- load-bearing frames with visible damages in the form of stand twists, section deformation,
- steel planks with damaged sheathing or damaged and bended catches,
- aluminium/plywood platforms -with visible damages of plywood sheathing in the form of stratification, cracks, bulges, decrements as well as bended load-bearing platform beams,
- screw footings with damaged threads, twisted plunger or resistive nuts.

Damaged elements should be replaced with the ones in working order. The elements that can be repaired should be handed back for reparation. Element straightening is permissible only when there are no deformations to circular section.

It is forbidden to perform repairs on load-bearing elements, e.g., frames, braces and adjustable footings.

### WARNING:

*Assembly manual does not substitute OHS rules at the construction site!  
Construction manager is responsible for proper scaffolding assembly and inspection!*



## 2. SCAFFOLDING ASSEMBLY UP TO 34 M HIGH

### 2. Scaffolding assembly up to 34 m high

#### 2.1. Preliminary actions

**2.1.1.** Before the assembly, check technical condition of all scaffolding elements.

**2.1.2.** Use only undamaged elements during assembly. Elements cannot have cracks, bended couplings, bended platform's catches, indentations and deformations of straight surfaces, catches containing screws with damaged threads, etc.

#### 2.2. Assembly guidelines for safer use

Personal protective equipment must be used during assembly, disassembly and use of the scaffolding. For greater safety of service, the following illustrations provide exemplary locations for attachment of the aforementioned equipment.

During scaffolding assembly, personal safety cord must be attached to facade side scaffolding elements. Cord and gusset plate binding must be performed with the frames that are higher than the level you are standing on. It is also applicable to fixing cartridges. When the frames of the assembled level are not bound together with railings, mount the safety cords to the wedge cartridge at the height of 1 m. It is allowable to attach the cord to the elements of the level you are standing on, but only when there is no other possibility. There are also ways to attach personal protective equipment directly to the structure surrounded by the scaffolding. The way of realization is individual to each structure.

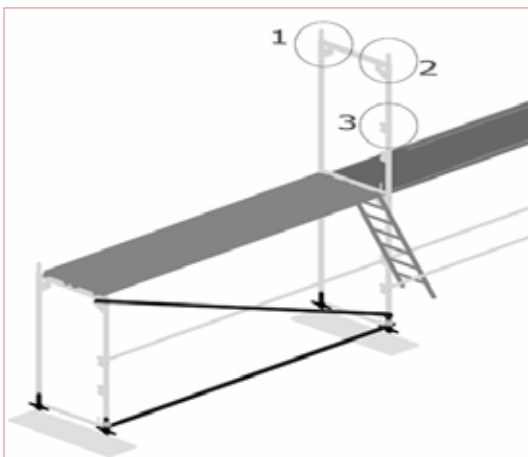

Fig. 2.1 – Recommended harness protection attachment points



Fig. 2.2a – Attachment to the wedge cartridge

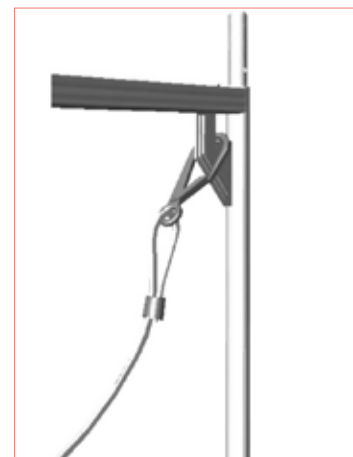

Fig. 2.2b – Attachment to the gusset plate

#### 2.2.1. Safety Kit

Assembly Safety Kit is a temporary safety precaution for the fitter. It is used during entry to the next level, before frames and railings are installed.

The kit consists of 2 assembly posts and telescopic railing. After the Safety Kit has been installed, the railing can be found one meter above the platform, over the tier where the post is attached. The post can be mounted and dismantled from the level of both tiers. Owing to the telescopic railing, it is possible to relocate the posts onto subsequent levels (without the need of dismantling the railings) and adjust the length of the set in the range of: **1.5 m up to 2.07 m – short version or 2.07 m up to 3.7 m – long version.**

The lightness of the structure makes the set relocation to the next scaffolding level (after the work is finished on the previous level) easy for the fitters.

#### Assembly stages:

1. Assembly post consists of two pipes that can be rotated and moved against joint axis. This allows the catch opening and closing. During proper installation of the post, the bolt in the bottom catch enters the opening in the closing metal plate (Fig. 2.3a).

#### WARNING:

*Assembly manual does not substitute OHS rules at the construction site!  
Construction manager is responsible for proper scaffolding assembly and inspection!*

2. By lifting and rotating external pipe of the post, attach the post to the frame, so the bottom catch leans on the upper railing of the scaffolding and the upper catch is placed between the pipe and gusset plate (Fig. 2.3b).
3. Mount the telescopic railing in the eye of the post.
4. Mount the other end of the telescopic railing in the eye of the post not yet mounted.
5. Mount the second post in the same manner as the first (section 2) on the other end of the scaffolding bay.
6. After railing's frame has been mounted on the upper level of the scaffolding, the Safety Kit can be relocated onto subsequent level by opening the railing post's catches and closing them on the higher level. Telescopic railing does not need to be dismantled during this procedure.



Fig. 2.3a

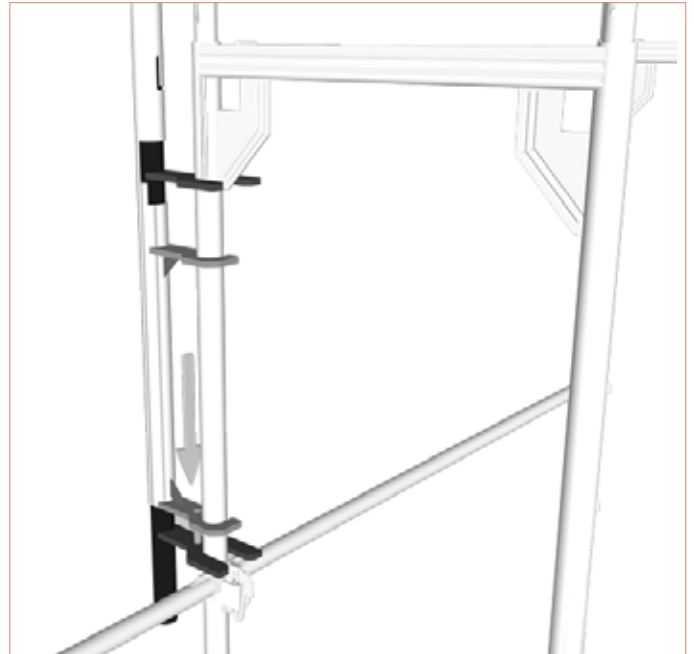

Fig. 2.3b

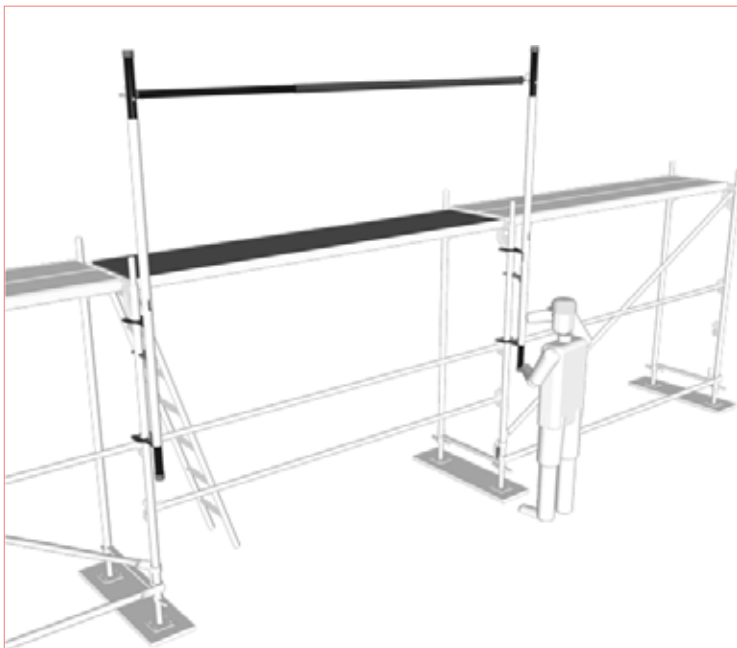

Fig. 2.3c

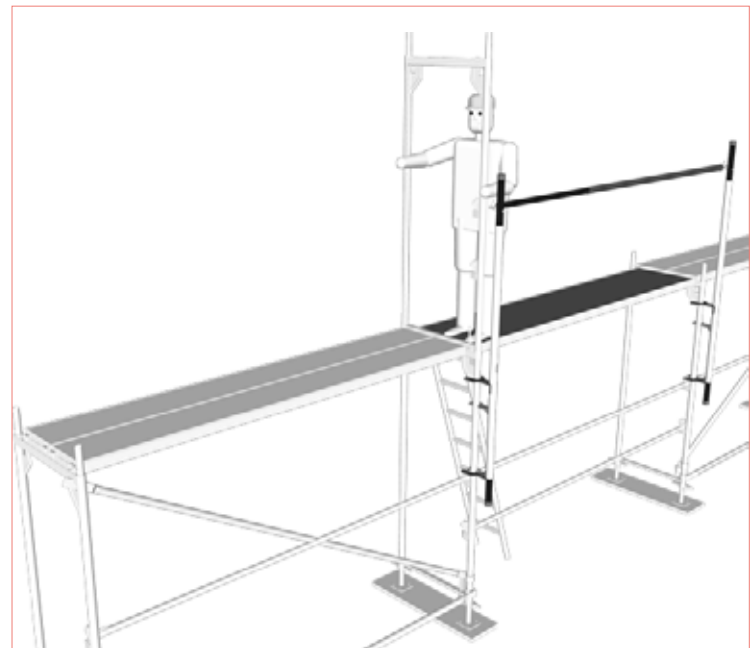

Fig. 2.3d

Safety Kit is required for the frame scaffoldings and all the sites where construction workers safety is highly regarded and the OHS rules obeyed.

**WARNING:**

*Assembly manual does not substitute OHS rules at the construction site!  
Construction manager is responsible for proper scaffolding assembly and inspection!*

## 2. SCAFFOLDING ASSEMBLY UP TO 34 M HIGH

### 2.3. Frame scaffolding assembly steps

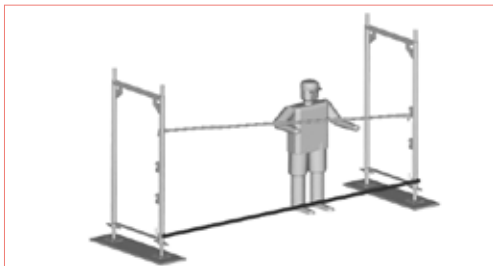

Fig. 2.1

#### STAGE I

Scaffolding assembly starts at the highest point of the ground, where the scaffolding will be placed. Place the adjustable footings (with the nuts unscrewed) at the proper distance. Proper spacing between footings can be established by placing railings in turn, on the ground. Place first two frames on the footings and connect them with railings (Fig. 2.1).

#### STAGE II

Place the platforms onto frames' U-profiles. Insert angle brace into frame's gusset plate's opening. Screw its other end, through the catch, to the opposite vertical frame (to its lower part). Using the plumbing jig, set the frames vertically and level the assembled bay. Starting from this initial bay, assemble subsequent bays by attaching frames onto footings, connecting them with assembled bays with the use of railings, and placing platforms (Fig. 2.2).

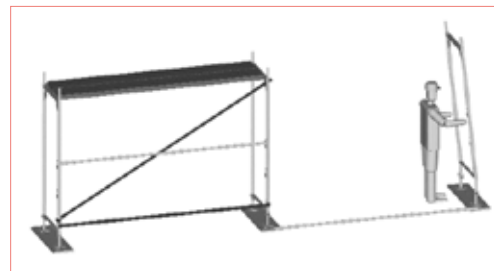

Fig. 2.2

**WARNING: Each braced bay has to contain horizontal brace. It is attached by screwing it onto frame's stands, right above the footing's nut (Fig 2.2).**

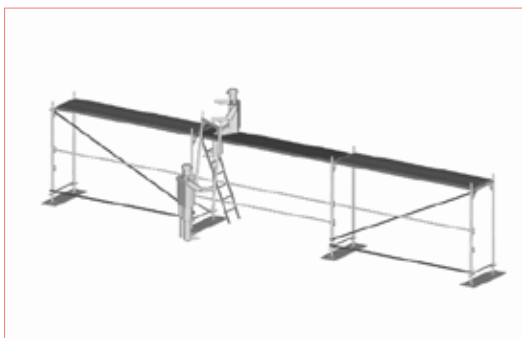

Fig. 2.3

#### STAGE III

Choose the bay for circulation path – internal entrance. Mount platform with a ladder and an entry hatch in this bay. Mount the lower end of ladder to vertical frame using ladder's bracket. Scaffolding should be braced in every fourth (maximum) bay of the scaffolding net screen, for the bay 3.07 m long, and every fifth for the bay 2.57 m long. In case of considerable terrain unevenness (on which the scaffolding is placed) and no possibility for level adjustment with base jacks' threaded nuts, use additional compensating frames measuring 0.6 m, 1 m, or 1.5 m for levelling (Fig. 2.3).

After first level has been assembled, perform careful plumbing, starting from the highest point of the ground.

#### STAGE IV

Placing frames for the next level begins with a circulation path. While standing on a scaffolding's previous level's ladder, attach the first frame for the next level (Fig. 2.4).

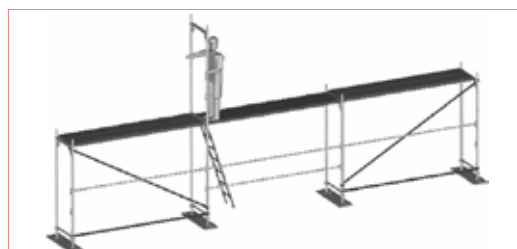

Fig. 2.4

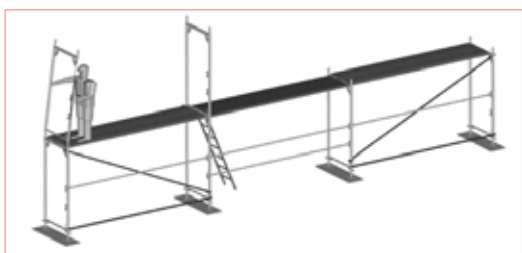

Fig. 2.5

#### STAGE V

Starting with that bay, mount further elements in both directions (Fig. 2.5).

**WARNING: During disassembly perform all the activities in reversed order. Always heading towards circulation path.**

#### WARNING:

*Assembly manual does not substitute OHS rules at the construction site!  
Construction manager is responsible for proper scaffolding assembly and inspection!*

### STAGE VI

Frames must be instantly inter-connected with railings, this way their mutual position can be established (Fig. 2.6).

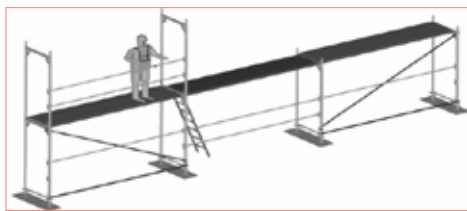

Fig. 2.6

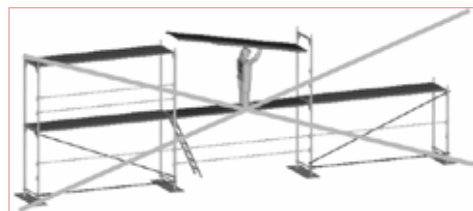

Fig. 2.6A

**WARNING: Do not place platforms on frames that are not inter-connected with railings (Fig. 2.6A). It may result in an accident and scaffolding elements damage.**

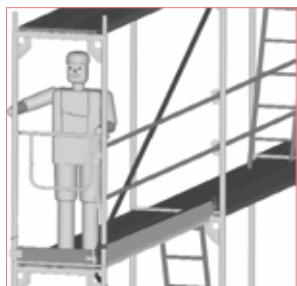

Fig. 2.7



Fig. 2.7A

### STAGE VII

Each level must be secured with front-end railings mounted at the front-end (Fig. 2.7). All scaffolding levels placed higher than 2 m must be secured with curbs. Curbs must be attached to frame's pegs (Fig. 2.7A). Platforms must be secured alongside the scaffolding with longitudinal curbs, and with transverse curbs from front-end (Fig. 2.7 and 2.7A).

### STAGE VIII

Place the platforms onto U-profiles of neighbouring frames. Perform anchoring as described in section 2.4.6. During each subsequent level assembly, follow the rules listed in stages IV-VIII (Fig. 2.8).

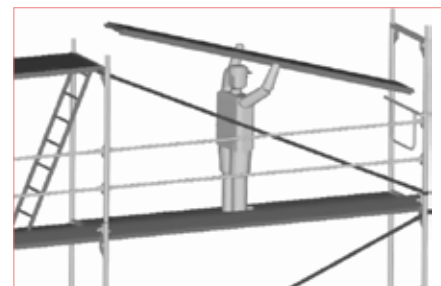

Fig. 2.8



Fig. 2.9

### STAGE IX

In order to secure proper internal communication, mount pass-by platforms with a ladder and a hatch. These platforms are mounted alternately in circular paths. The hatch is secured from accidental opening. The hatch can be opened only when passing from one level to another. After entering or leaving the platform, always remember to close the hatch. Subsequent level assembly always begins with frame placement above the passage hole. In order to secure the highest scaffolding level, mount railing posts and railings. Place the first post in the circulation path (Fig. 2.9).

Secure the scaffolding at the front-end side by mounting front-end frame. Mount longitudinal and transverse curbs (Fig. 2.10).



Fig. 2.10

The following rules must be observed during assembly:

- anchor mounting can be performed consecutively to entire scaffolding assembly, accordingly to anchoring grid established for the scaffolding,
- each level requires separate plumbing with a plumbing jig. Plumbing must be performed in the bays with vertical braces. Scaffolding plumbing correction is performed by the adjustment of lower brace's coupling against frame's vertical pipe.

During disassembly perform all the activities in reversed order.

### WARNING:

*Assembly manual does not substitute OHS rules at the construction site!  
Construction manager is responsible for proper scaffolding assembly and inspection!*



## 2. SCAFFOLDING ASSEMBLY UP TO 34 M HIGH

### 2.4. Assembly rules important from safety point of view

#### 2.4.1. Scaffolding levelling

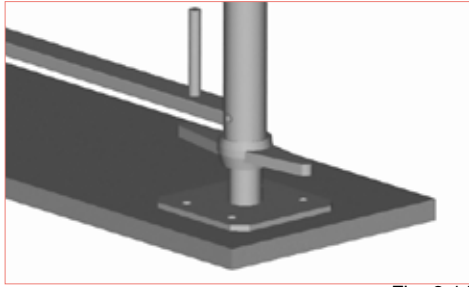

Fig. 2.11

Scaffolding assembly starts at the highest point of the ground, with base jacks' nuts in lowest position. The nut is used to level the scaffolding frame (Fig. 2.11). If the scaffolding is placed on ground base than use only footings underlaid with wooden pads that distribute the scaffolding load onto the larger surface. It is recommended to use the pads also when the scaffolding is placed on construction base. At least two screw footings should be placed on a single pad.

If a ground fault is considerable then compensating frames as high as 0.6 m, 1 m, or 1.5 m must be used (Fig. 2.12).

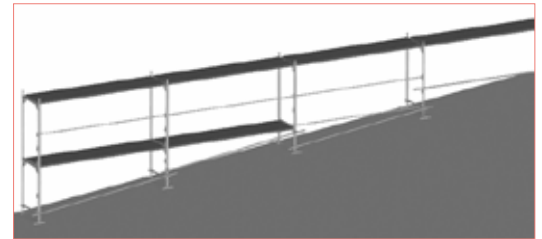

Fig. 2.12

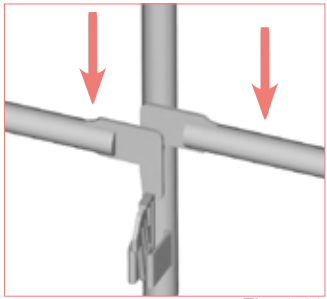

Fig. 2.13

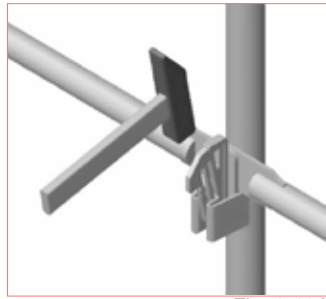

Fig. 2.13A

#### 2.4.2. Side protection

Each platform must be secured with a single upper railing and intermediate railing (lower) and longitudinal curb. Railing are mounted on frame carriages and secured with a wedge (Fig. 2.13 and 2.13A). Railings at the wall side are mounted to stands with the use of railing couplings with a wedge.

Curbs must be attached to frame's pegs (Fig. 2.14).

Curbs at the wall side are made of planks measuring 3 x 15 cm. Planks must be attached to stands with curbs' catches. Plank must be 20–40 cm longer than the bay, where it will be mounted. It is allowed to omit railings and curbs at the building side of the platform, but only if the gap between the wall and platform's edge does not exceed 0.2 m, and when the platform's height does not exceed 1 m from ground level. It is allowable to secure the platform with net screen.

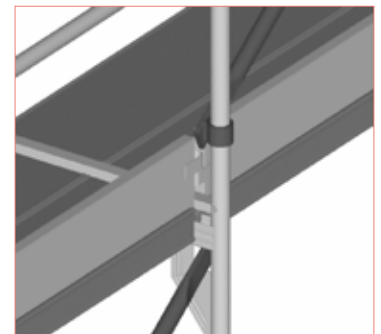

Fig 2.14

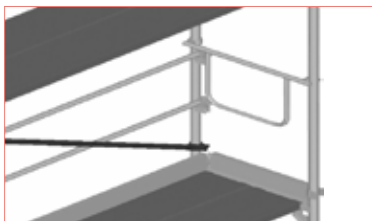

Fig. 2.15



Fig. 2.16

#### 2.4.3. Securing the front-end of the scaffolding

Front-end security is performed by mounting the front-end railing (Fig. 2.15). Platforms placed on wide bracket must be secured at facade side with front-end frame. Front-end railing is mounted inversely comparing to the way vertical frames are mounted (Fig. 2.16). Make sure that in this position the upper side of the railing is placed at the height of 1–1.1 m against the platform.

#### WARNING:

Assembly manual does not substitute OHS rules at the construction site!  
Construction manager is responsible for proper scaffolding assembly and inspection!

### 2.4.4. Scaffolding bracing

Upper end of vertical brace is put into opening in gusset plate. Lower end is attached to the frame with rotary coupling (Fig. 2.17). Subsequently, in each braced bay on each level, frame plumbing must be performed with the use of plumbing jig.

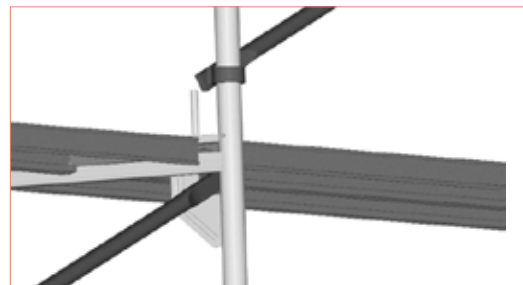

Fig. 2.17

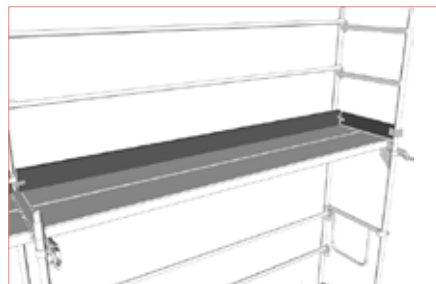

Fig. 2.18

### 2.4.5. Scaffolding's highest level protection

Highest level is secured by mounting front-end frame at the scaffolding's front end and railing posts along the scaffolding and railings. Posts are securing the platforms from falling out (Fig. 2.18).

### 2.4.6. Scaffolding anchoring – types of anchors

Scaffolding is anchored with wall ties that are mounted with standard catches to frame's stand below working platform, and to the building structure (Fig. 2.19).



Fig. 2.19



Fig. 2.20

Couplings are equipped with hooks that connect the scaffolding with anchoring screws (with an eye) that are attached to the wall or to the building structure (Fig. 2.20). Coupling runs through an eye of the screw with the middle part of the hook (about 50 mm against top edge of coupling's pipe). The horizontal set-up of screw's eye allows horizontal forces to pass from the scaffolding onto the building.

### 2.4.7. Passageways on scaffoldings

In order to secure proper internal communication on the scaffolding, mount platforms with a ladder and a hatch. The hatch must remain closed at all times (Fig. 2.21). In order to assure comfort and proper work ergonomics, staircases can be installed as an alternative (page 14, section 2.4.14.).



Fig. 2.21



Fig. 2.22

### 2.4.8. Protection during roof works

In order to secure the works on the roof, install net screen posts and net screens on the highest scaffolding level (Fig. 2.22). After the net screens are mounted, there is no need to mount the longitudinal curbs.

#### WARNING:

Assembly manual does not substitute OHS rules at the construction site!  
Construction manager is responsible for proper scaffolding assembly and inspection!

## 2. SCAFFOLDING ASSEMBLY UP TO 34 M HIGH

### 2.4.9. Scaffolding inter-connection

At the point of bay convergence, external frame's pipes are connected with a section of a pipe and two normal couplings (Fig. 2.23). Pipes that connect two bays also act as a side protection. The space between bays is covered with steel, filling platforms or planks secured from the wind.

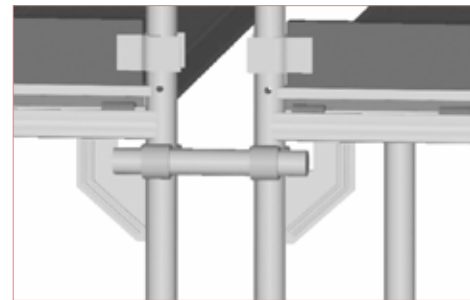

Fig. 2.23



Fig. 2.24

### 2.4.10. Pathways beneath scaffoldings

Passage frames are mounted in order to provide passage for pedestrians under the scaffolding (Fig. 2.24). Frames must be inter-connected with longitudinal transoms. The connection must be performed directly above the screw footing's nut, parallel to facade. Maximum height of the scaffolding constructed with passage frames equals 34 m (all the I and II level nodes must be anchored).

### 2.4.11. Gate entrances (passages under the scaffolding)

In order to construct the passage under the scaffolding use grate girders mounted on the external sides of neighbouring frames with the use of normal couplings. Each girder is attached to frames' stands with 4 couplings. When the passage is more than 3.07 m wide, mount girder's transom e503573 or compensating frame measuring 0.6 m, on which subsequent level's frames can be placed (Fig. 2.25).

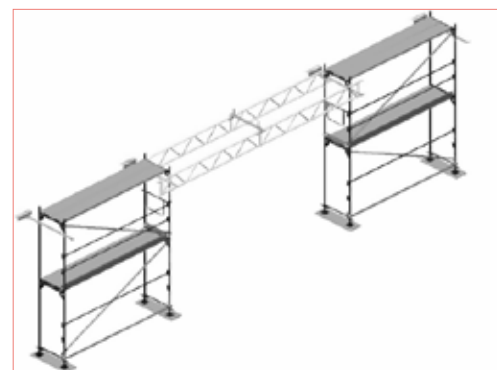

Fig. 2.25

When a passage under the scaffolding is constructed with a grate girder, remember that only two bays can be replaced with a passage. For scaffoldings measuring up to  $20 \leq H \leq 34$  m and width of 1.09 m, additional structure strengthening must be constructed above the girder and universal, 6 m long pipes must be mounted in order to reinforce the frames' stands in the passage area (see page 34).

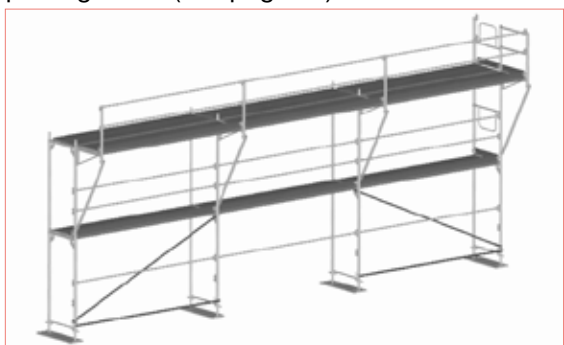

Fig. 2.26

### 2.4.12. Scaffolding expansion

In order to expand steel scaffolding working space, brackets are mounted on the outside or inwards. It is allowed to expand the scaffolding platform with the use of steel brackets measuring 0.36 m and 0.73 m. Brackets measuring 0.36 m can be mounted at the internal side of the scaffolding (facade side) on each level.

Brackets must be mounted at the height of gusset plate. Bracket's platform load cannot exceed permissible load levels of the main platform (Fig. 2.26 and 2.27).

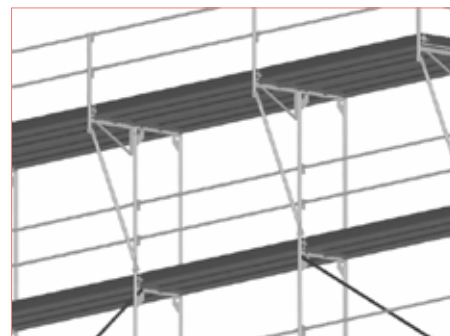

Fig. 2.27

#### WARNING:

Assembly manual does not substitute OHS rules at the construction site!  
Construction manager is responsible for proper scaffolding assembly and inspection!

Brackets measuring 0.73 m can be mounted on external side of the scaffolding, on its last level, or on any level with obligatory anchoring of the extension to the wall with mounted bracket, and to one level above and below.

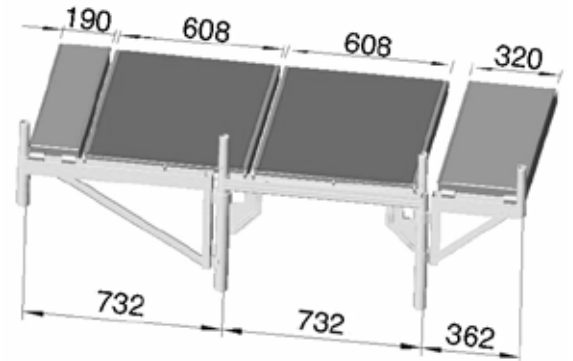

Fig. 2.28

Platform placement on the scaffolding with expansions are depicted below.

Platforms must be assembled in a way that the gap between two platforms on one level would not exceed 15 mm (larger gaps are acceptable, but they cannot exceed 25 mm between platform placed on 0.36 m high bracket and a platform placed on vertical frame).

– steel planks 0.32 m and 0.19 m wide

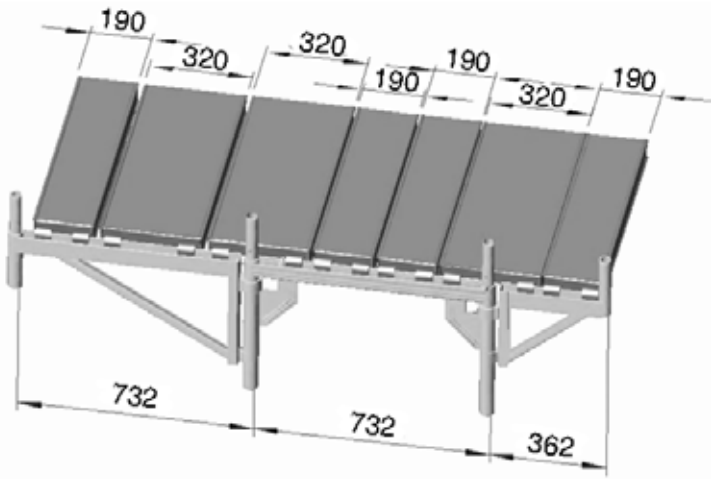

Fig. 2.29

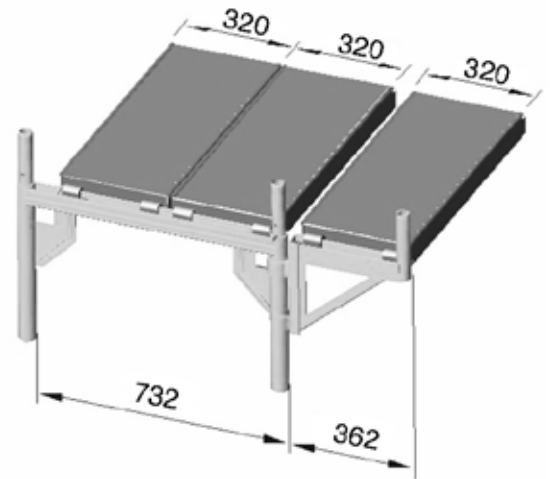

Fig. 2.30

– aluminium/plywood platforms - 0.6 m wide, and steel planks - 0.19 m wide

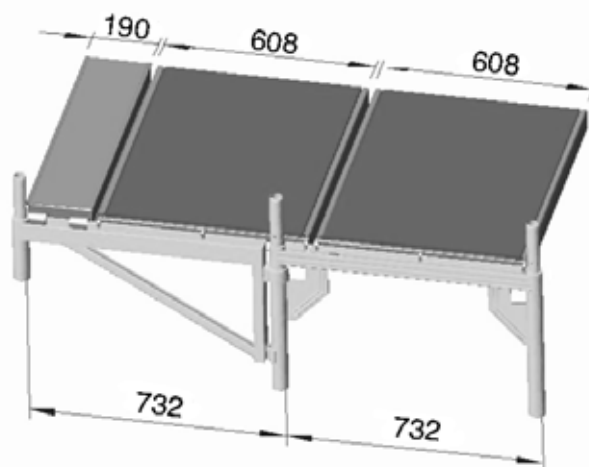

Fig. 2.31

**WARNING:**

Assembly manual does not substitute OHS rules at the construction site!  
Construction manager is responsible for proper scaffolding assembly and inspection!

## 2. SCAFFOLDING ASSEMBLY UP TO 34 M HIGH



Fig. 2.32

### 2.4.13. Protective roof

In order to secure the safety of pedestrians walking by the scaffolding, protective roof is mounted. It consists of steel bracket 0.73 m high connected with a frame, and a roof bracket. Roof bracket is paved with platforms. Each frame that supports the protective roof must be anchored to the building (Fig. 2.23).

**WARNING:** Protective roof, as depicted on figure 2.23, is not a sufficient protection according to PN-M-47900-2:1996 section 4.10.3.

### 2.4.14. External staircases

In order to secure proper internal communication, external staircases are installed. Typically, external staircase is mounted in the bay measuring 3.07 m or 2.57 m, according to one of the two presented schemes. Additionally, installed frames are connected with frame scaffolding every 4 m vertically, with frame scaffolding nodes anchored in the connection points. The connections are performed with pipes  $\varnothing 48.3 \times 3.2$  mm and normal couplings. Front-end surfaces of staircases are secured with front-end railings. External surfaces must be secured with stairs' external railings, and internal surfaces with – stairs' internal railings.

**Fig. 2.1**

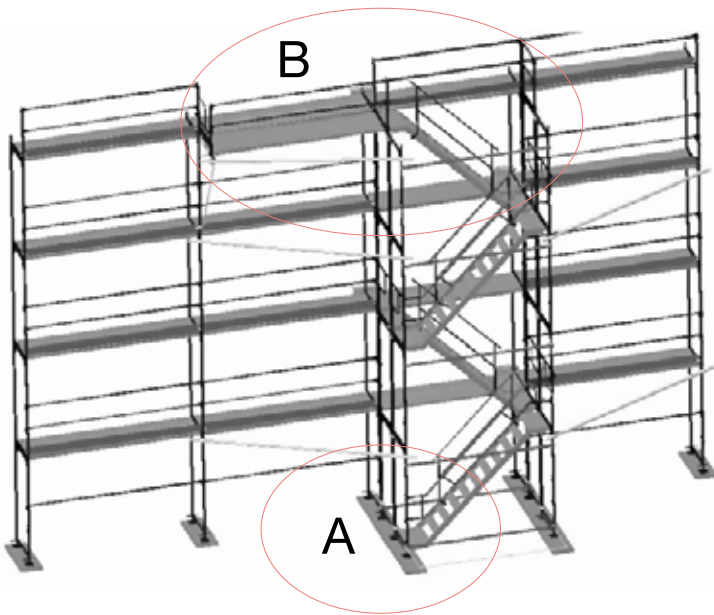

Fig. 2.4 – Complete view

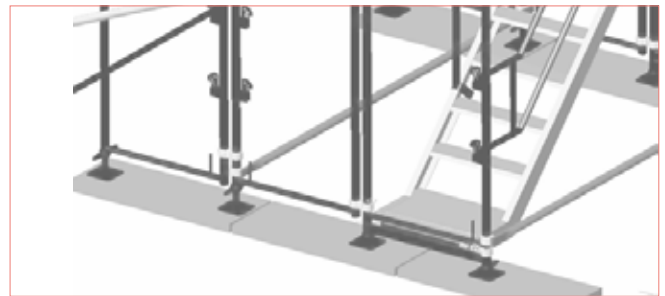

Fig. 2.5 – Detail A



Fig. 2.6 – Detail B

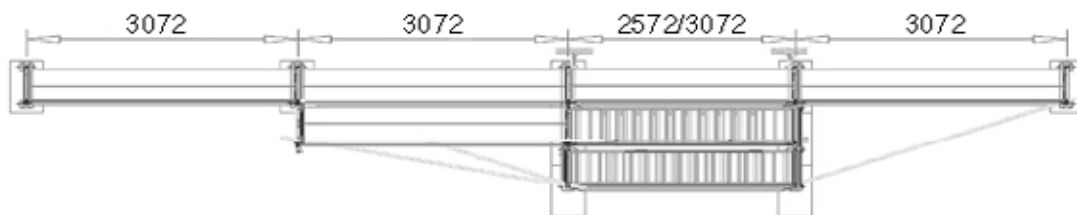

Fig. 2.1 – Canopy view

**WARNING:**

Assembly manual does not substitute OHS rules at the construction site!  
Construction manager is responsible for proper scaffolding assembly and inspection!



**Fig. 2.2**

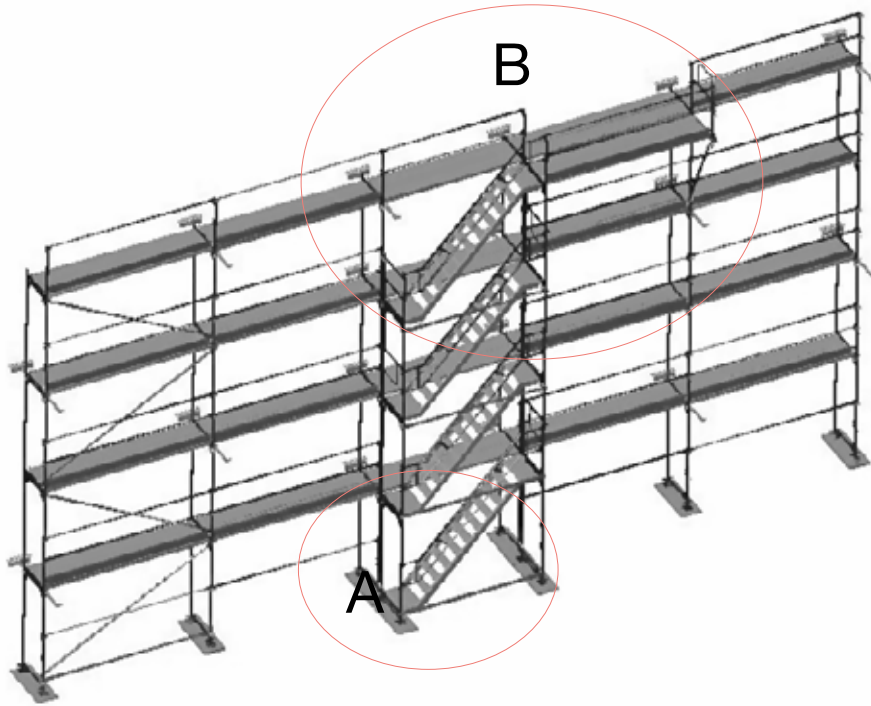

Fig. 2.7 – Complete view

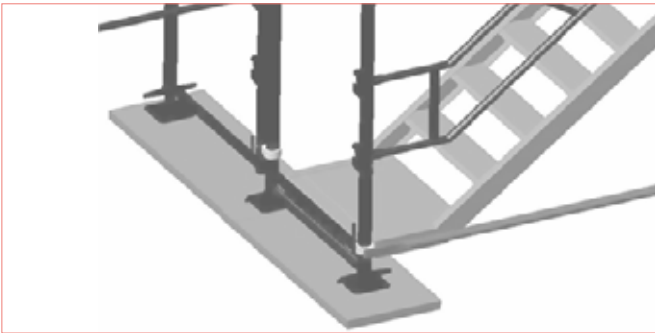

Fig. 2.8 – Detail A

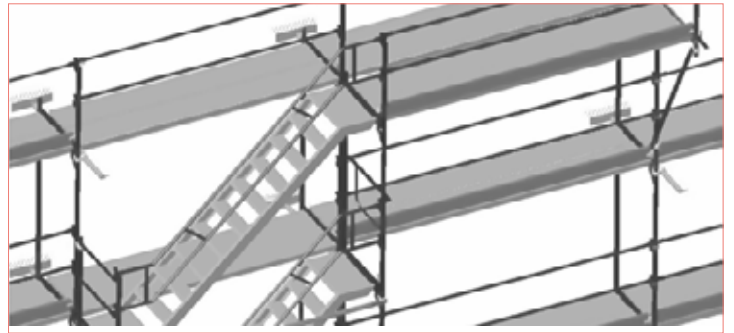

Fig. 2.9 – Detail B

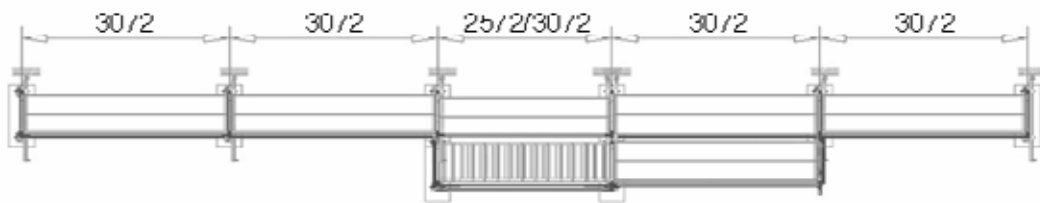

Fig. 2.2 – Canopy view

**WARNING:**

Assembly manual does not substitute OHS rules at the construction site!  
Construction manager is responsible for proper scaffolding assembly and inspection!

## 2. SCAFFOLDING ASSEMBLY UP TO 34 M HIGH

### 2.4.15. Material transportation

Scaffolding can be equipped with material transportation tool with outriggers attached to scaffolding structure. Standard block (offer No. e552100) can be utilized. Transport outrigger must be additionally anchored in at least two places, as shown in the illustration below.

Maximum weight of lifted materials cannot exceed 150 kg. When using scaffolding attached winches with larger load capacities, static proof calculations must be performed for the scaffolding due to its non-standard design.

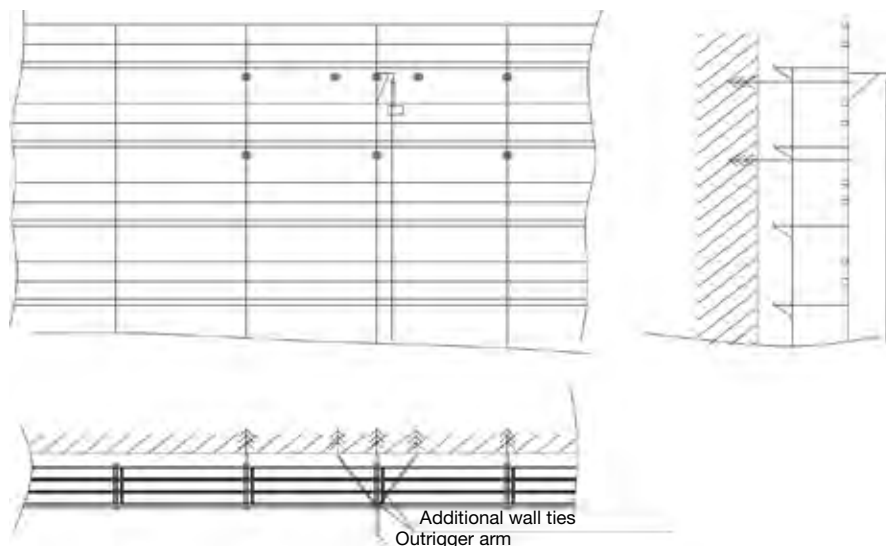

Fig. 2.3 – Additional anchors for a mounted bracket

**WARNING: Additionally, anchor two adjacent frames at each side of the outrigger at the tier level and one tier above and below.**

Distance between outriggers cannot be smaller than 30 m. Distance from the outrigger to closer end of the scaffolding cannot be smaller than 15 m. The height from block's point of attachment to the level of the platform cannot be smaller than 1.6 m. For vertical transport it is advisable to use winches adapted for scaffoldings, e.g. winches made by GEDA. The devices must have UDT (Office of Technical Inspection) commissioning certificates. Winch assembly must be performed only as directed by user manual.

### 2.5. Rules for anchoring and assembly of braces

#### 2.5.1. General anchoring rules:

- anchoring begins at the second level, perform anchoring with the use of distance wall ties and two normal couplings,
- anchors must be placed symmetrically, on entire surface,
- horizontal distance between anchors cannot exceed 6 m (anchor every second bay in case of bay 3.07 m long),
- distance between vertical rows of anchors cannot exceed 4 m (anchor every second level). Anchors in rows should be shifted horizontally against each other,
- each anchor raw must end at the edge of scaffolding,
- in case of bays with circulation paths, adjoining bays (in the same raw) must also be anchored,
- it is allowable to anchor 30 cm below or above the opening in gusset plate.

In case of scaffoldings covered with canvases or scaffolding net screens with mounted gate girders, passage frames and protective canopies, additional anchors are required. The placement and number of these anchors is shown in the illustrations, which can be found in further part of this manual.

In case of scaffolding anchoring performed with one coupling attached to internal stand (scaffolding with mounted bracket 0.36 m at the internal side of scaffolding), 20% of total number of anchors must be constructed as double anchors, according to the scheme. Anchors must be placed evenly on entire surface. At least two V-type anchors must be mounted on each anchored level.

#### WARNING:

*Assembly manual does not substitute OHS rules at the construction site!  
Construction manager is responsible for proper scaffolding assembly and inspection!*

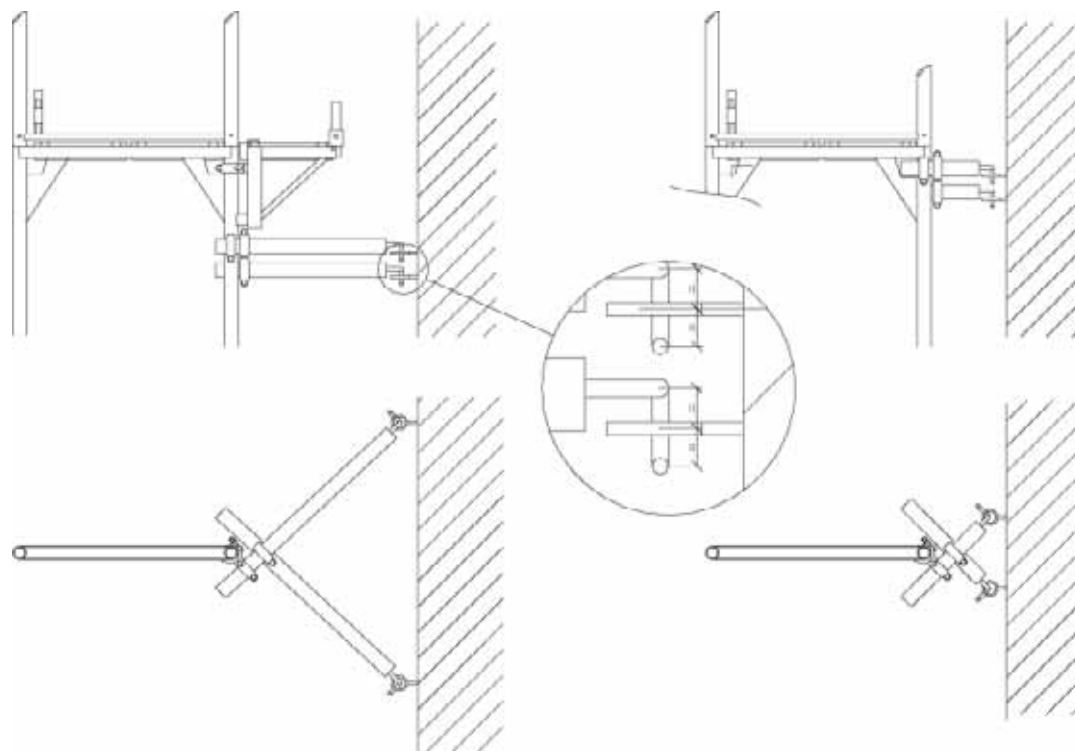

Fig. 2.4 – V-type anchors example

### 2.5.2. Assembly rules for angle braces:

- tower shaped angle braces must be zigzagged. At least every fifth bay must be braced (for a module  $L = 2.57$  m) or in every fourth bay (for a module  $L = 3.07$  m). Always anchor continuously starting from footing upwards. Maximum distance between braces cannot exceed 10 m,
- angle brace must be placed symmetrically to scaffolding's length,
- number of braces on each level cannot be less than 2,
- large-format braces must be mounted in the following manner: one brace for 5 bays of each level,
- large-format braces must be mounted slantwise across 5 bays. After slant bend, again across the same 5 bays.

### 2.5.3. Combination of forces in anchorings and footings of typical sets

Forces in anchors and footings are presented in tables that can be found near the scaffolding set-up schemes.

### 2.5.4. Braces and anchors arrangement for non-shielded scaffolding up to 34 m high

**WARNING: Scaffoldings mounted on objects accordingly to schemes presented in this manual do not require static proof calculations. All the data contained in set descriptions was verified with static proof calculations. The set usage is entirely safe when requirements described on the schemes are followed. All set-ups that are different than set-ups described in this manual must undergo static proof calculations in order to verify its stability.**

The term '**closed facade**' describes building facade surface (with a scaffolding mounted on) entirely covered with air-proof material (concrete, glass, composite, wood, etc.).

The term **semi open facade** describes building facade, where up to 60% of the surface covered with a scaffolding is not filled with air-proof material (there are passage openings). In this type of facade there is a possibility of wind passing through the building.

**WARNING:**

*Assembly manual does not substitute OHS rules at the construction site!  
Construction manager is responsible for proper scaffolding assembly and inspection!*

## 2. SCAFFOLDING ASSEMBLY UP TO 34 M HIGH

Scaffolding without covering, closed facade\*

Gate crossing option

Working platform load of 2 kN/m<sup>2</sup>

Safety platform load of 1 kN/m<sup>2</sup>

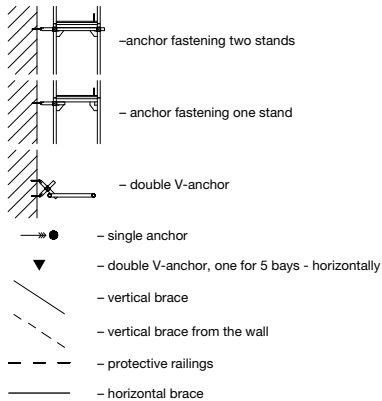

Type of facade filling	closed facade		
Vertical anchoring spacing	4 m		
Horizontal anchoring spacing	every second bay		
Maximum force in the anchor (kN)		1.9	
		4.8	
Maximum force in the foot (kN)	internal stand	23.4	01
	external stand	52.2	

\* closed facade, when number of openings is less than 20% of facade surface

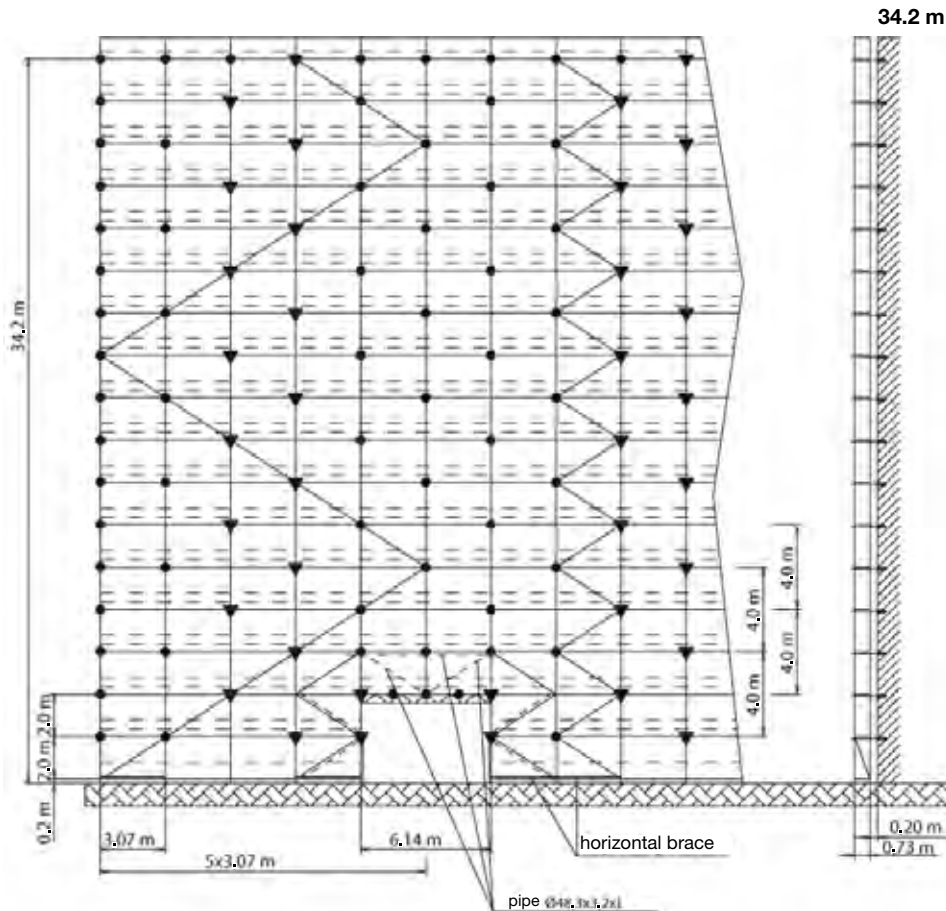

Scaffolding without covering, closed facade\*

Basic option

Working platform load of 2 kN/m<sup>2</sup>

Safety platform load of 1 kN/m<sup>2</sup>

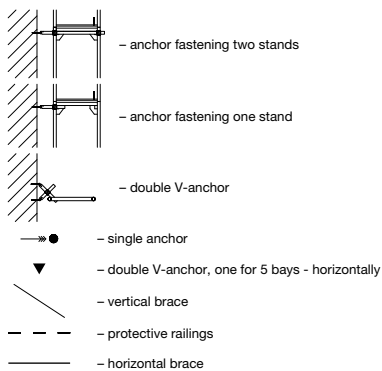

Type of facade filling	closed facade		
Vertical anchoring spacing	4 m		
Horizontal anchoring spacing	every second bay		
Maximum force in the anchor (kN)		2.8	
		4.8	
Maximum force in the foot (kN)	internal stand	16.3	03
	external stand	55.1	

\* closed facade, when number of openings is less than 20% of facade surface

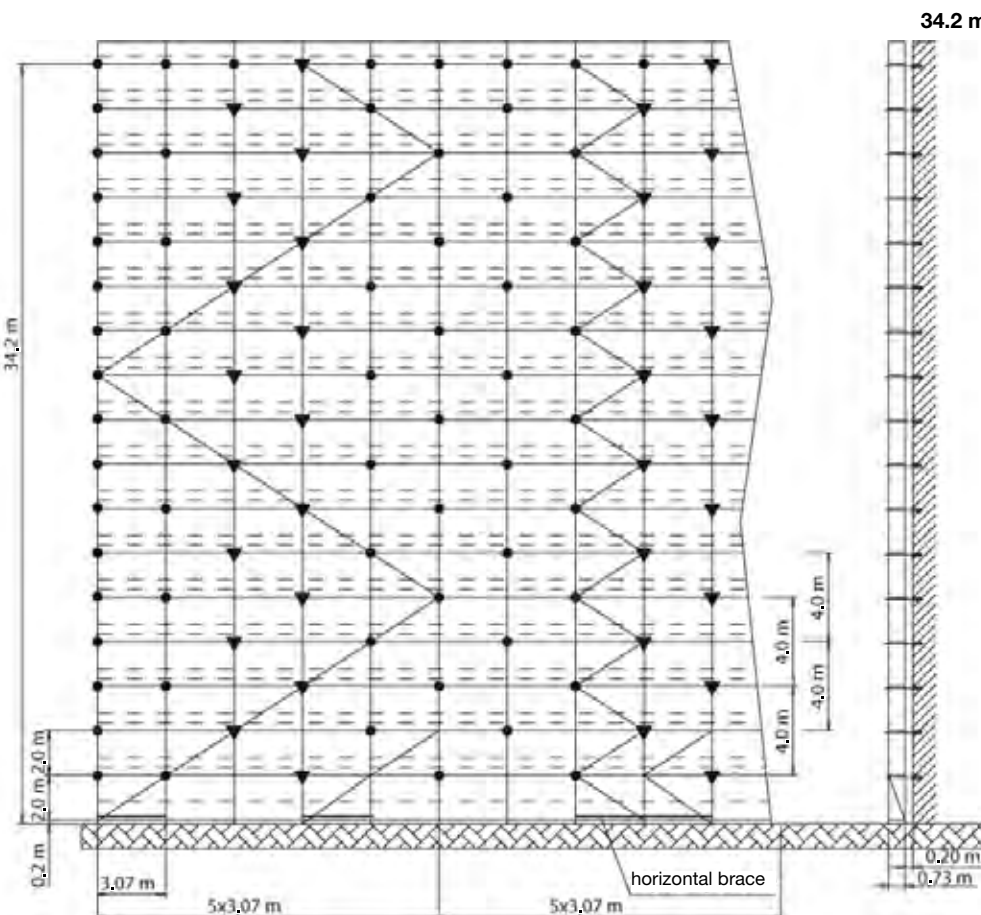

### WARNING:

Assembly manual does not substitute OHS rules at the construction site!  
Construction manager is responsible for proper scaffolding assembly and inspection!



Scaffolding without covering, closed facade\*  
 Working platform load of 2 kN/m<sup>2</sup>  
 Safety platform load of 1 kN/m<sup>2</sup>  
 Option: bracket 0.73 m – external, last level  
 + bracket 0.36 m – inside, all levels

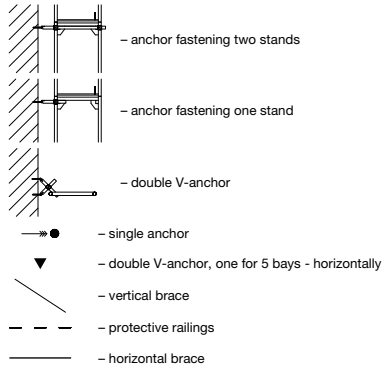

Type of facade filling	closed facade		
Vertical anchoring spacing	4 m		
Horizontal anchoring spacing	every second bay		
Maximum force in the anchor (kN)		2.1	05
		4.7	
Maximum force in the foot (kN)	internal stand	29.4	05
	external stand	62.4	

\* closed facade, when number of openings is less than 20% of facade surface

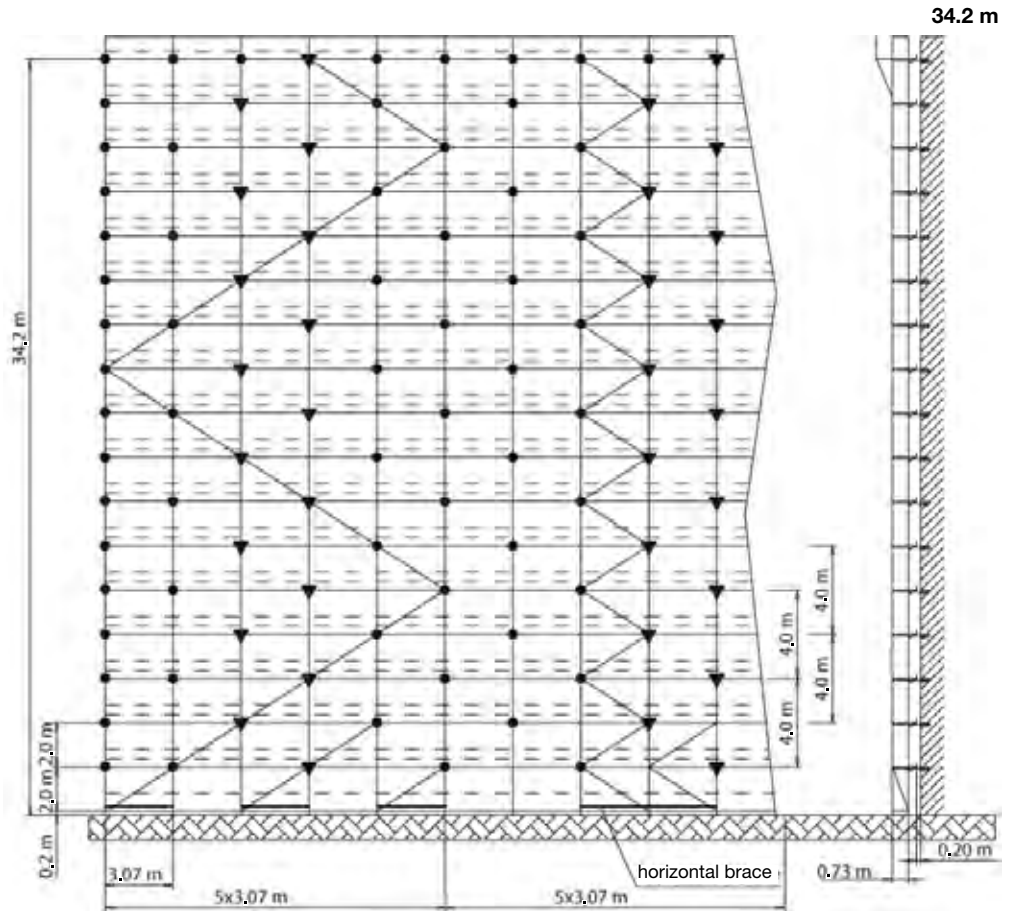

Scaffolding without covering, closed facade\*  
 Passage frame option  
 Working platform load of 2 kN/m<sup>2</sup>  
 Safety platform load of 1 kN/m<sup>2</sup>  
 Vertical brace on two levels, 2 for every 5 bays

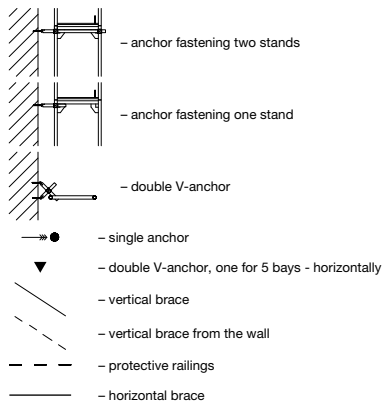

Type of facade filling	closed facade		
Vertical anchoring spacing	4 m		
Horizontal anchoring spacing	every second bay		
Maximum force in the anchor (kN)		2.3	07
		4.8	
Maximum force in the foot (kN)	internal stand	25.1	07
	external stand	49.7	

\* closed facade, when number of openings is less than 20% of facade surface

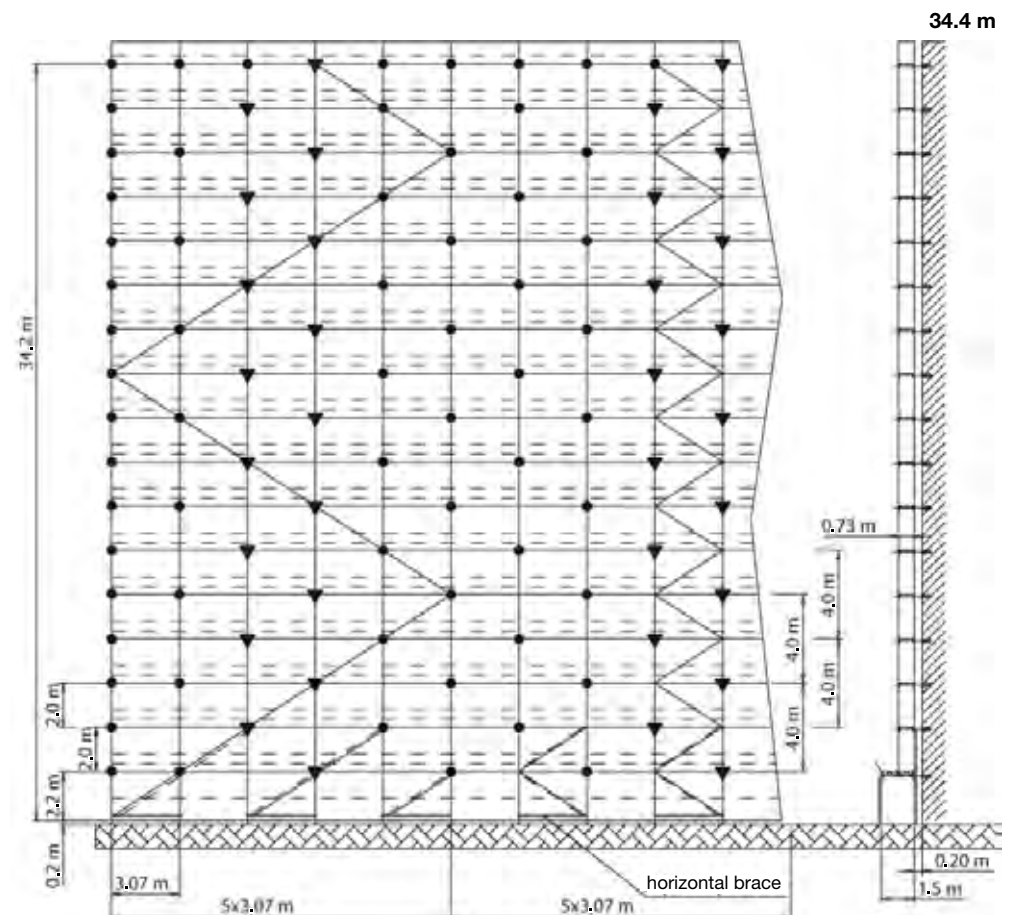

### WARNING:

Assembly manual does not substitute OHS rules at the construction site!  
 Construction manager is responsible for proper scaffolding assembly and inspection!



# FRAME SCAFFOLDINGS – ASSEMBLY MANUAL

## 2. SCAFFOLDING ASSEMBLY UP TO 34 M HIGH

Scaffolding without covering, semi-open facade\*

Gate crossing option

Working platform load of 2 kN/m<sup>2</sup>

Safety platform load of 1 kN/m<sup>2</sup>

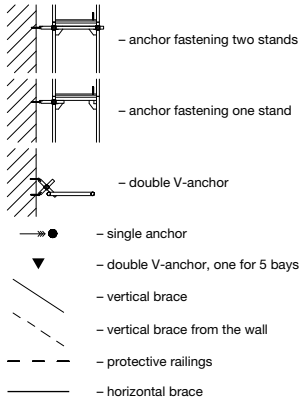

Type of facade filling	semi-open facade		
Vertical anchoring spacing	4 m		
Horizontal anchoring spacing	every second bay		
Maximum force in the anchor (kN)		1.9	
	⊥	4.8	
Maximum force in the foot (kN)	internal stand	23.4	09
	external stand	52.1	

\* semi-open facade, when the number of openings in the facade is within the range of 0% to 60%

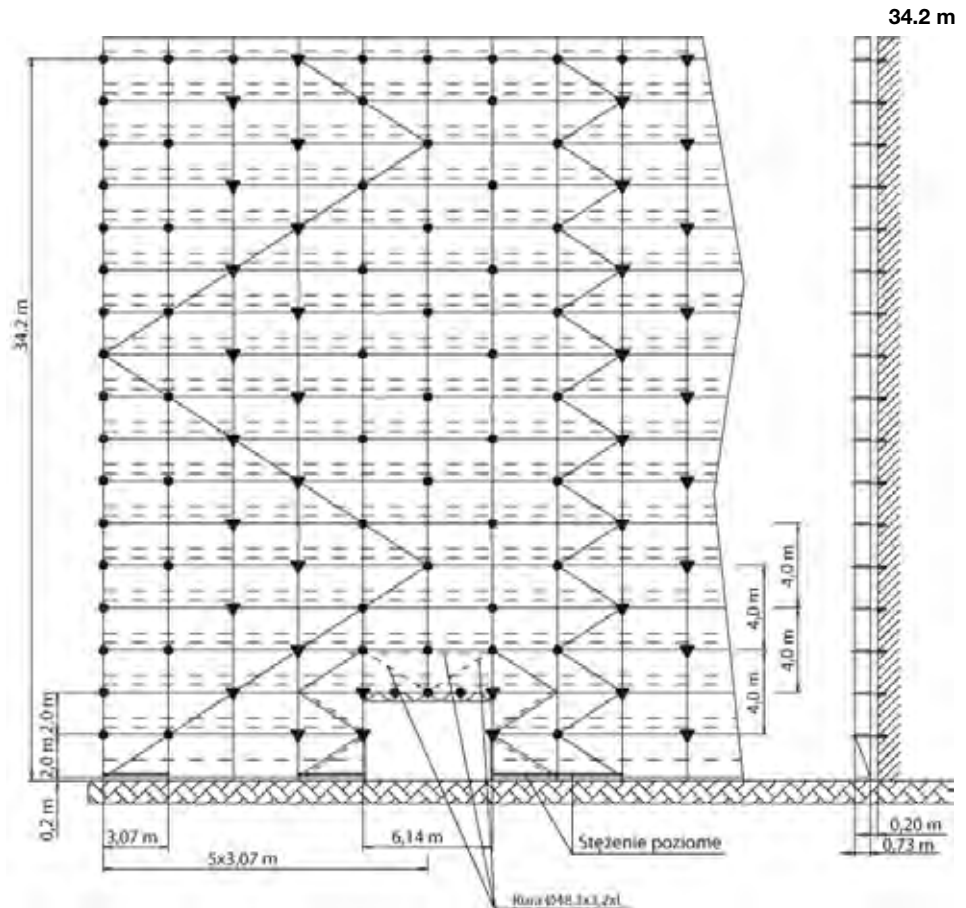

Scaffolding without covering, semi-open facade\*

Basic option

Working platform load of 2 kN/m<sup>2</sup>

Safety platform load of 1 kN/m<sup>2</sup>

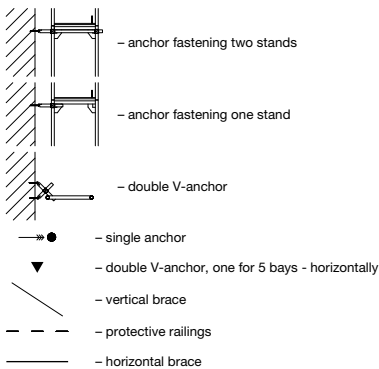

Type of facade filling	semi-open facade		
Vertical anchoring spacing	4 m		
Horizontal anchoring spacing	every second bay		
Maximum force in the anchor (kN)		2.8	
	⊥	4.8	
Maximum force in the foot (kN)	internal stand	17.1	10
	external stand	55.1	

\* semi-open facade, when the number of openings in the facade is within the range of 0% to 60%

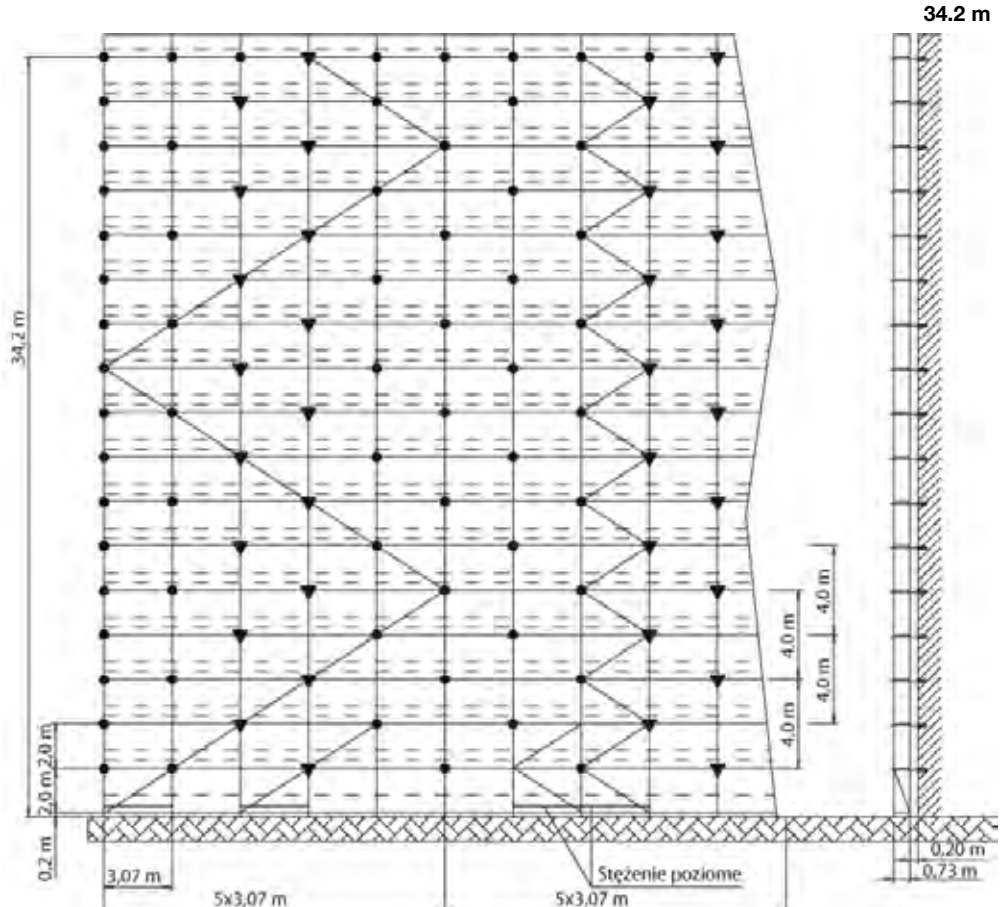

### WARNING:

Assembly manual does not substitute OHS rules at the construction site!  
Construction manager is responsible for proper scaffolding assembly and inspection!

Scaffolding without covering, semi-open facade\*  
 Working platform load of 2 kN/m<sup>2</sup>  
 Safety platform load of 1 kN/m<sup>2</sup>  
 Option: bracket 0.73 m – external, last level  
 + bracket 0.36 m – inside, all levels

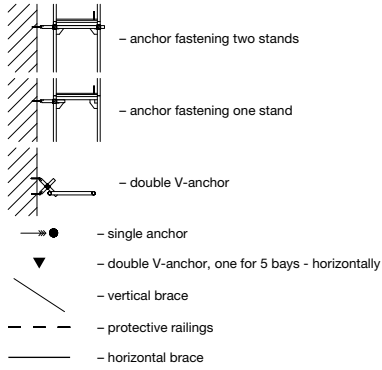

Type of facade filling	semi-open facade		
Vertical anchoring spacing	4 m		
Horizontal anchoring spacing	every second bay		
Maximum force in the anchor (kN)		2.1	11
		4.7	
Maximum force in the foot (kN)	internal stand	30.2	11
	external stand	62.4	

\* semi-open facade, when the number of openings in the facade is within the range of 0% to 60%

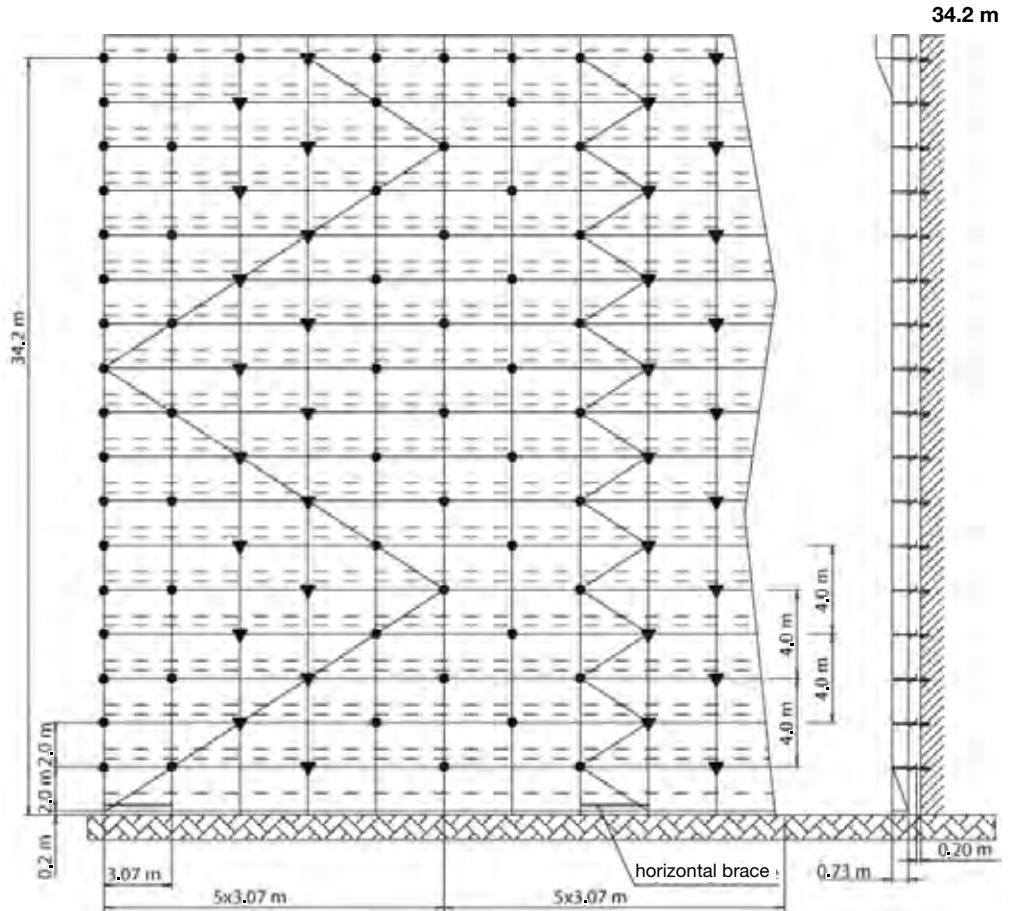

Scaffolding without covering, semi-open facade\*  
 Passage frame option  
 Working platform load of 2 kN/m<sup>2</sup>  
 Safety platform load of 1 kN/m<sup>2</sup>  
 Vertical brace on two levels, 2 for every 5 bays

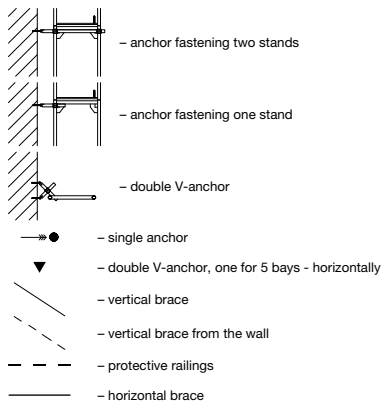

Type of facade filling	semi-open facade		
Vertical anchoring spacing	4 m		
Horizontal anchoring spacing	every second bay		
Maximum force in the anchor (kN)		2.3	12
		4.8	
Maximum force in the foot (kN)	internal stand	25.5	12
	external stand	49.1	

\* semi-open facade, when the number of openings in the facade is within the range of 0% to 60%

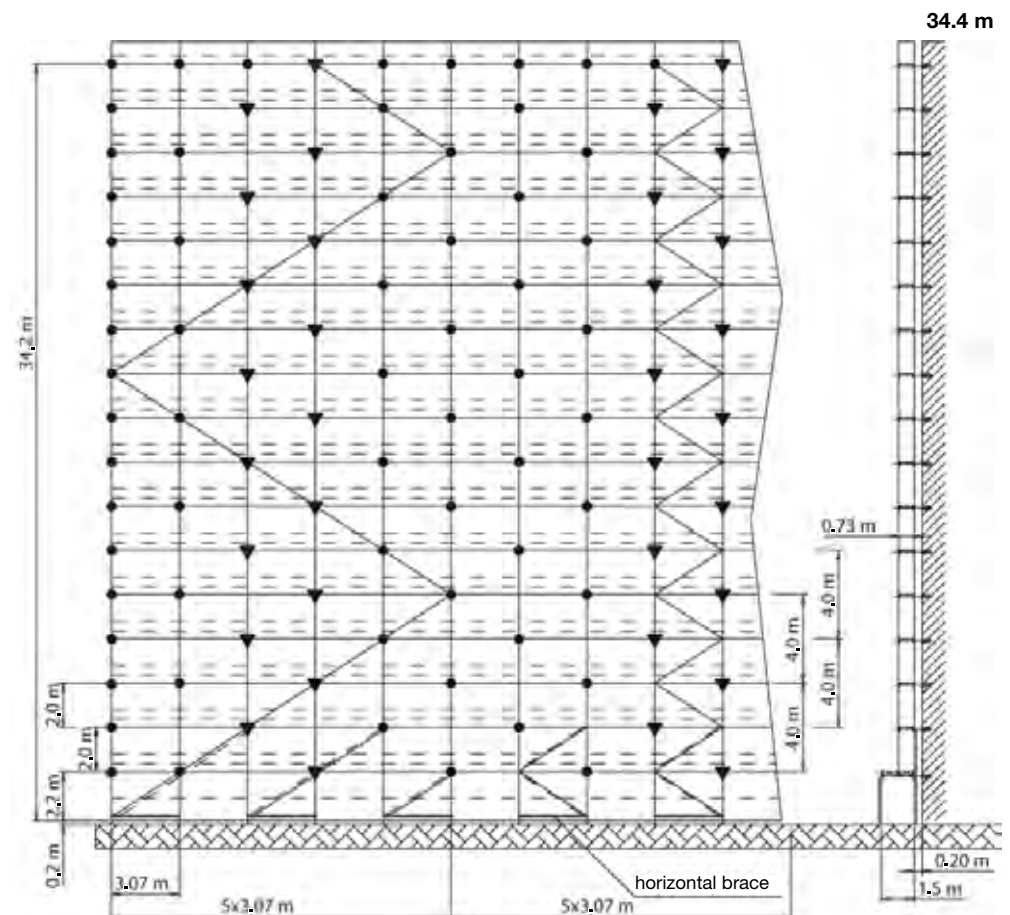

### WARNING:

Assembly manual does not substitute OHS rules at the construction site!  
 Construction manager is responsible for proper scaffolding assembly and inspection!



## 2. SCAFFOLDING ASSEMBLY UP TO 34 M HIGH

24.2 m

Scaffolding without covering, closed facade\*

Gate crossing option

Working platform load of 2 kN/m<sup>2</sup>

Safety platform load of 1 kN/m<sup>2</sup>

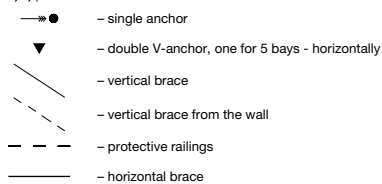
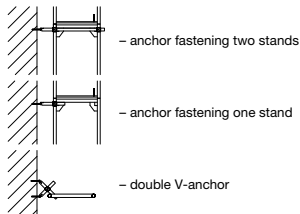

Type of facade filling	closed facade		
Vertical anchoring spacing	8 m		
Horizontal anchoring spacing	every second bay		
Maximum force in the anchor (kN)		2.8	
	⊥	4.2	
Maximum force in the foot (kN)	internal stand	20.5	13
	external stand	34.1	

\* closed facade, when number of openings is less than 20% of facade surface

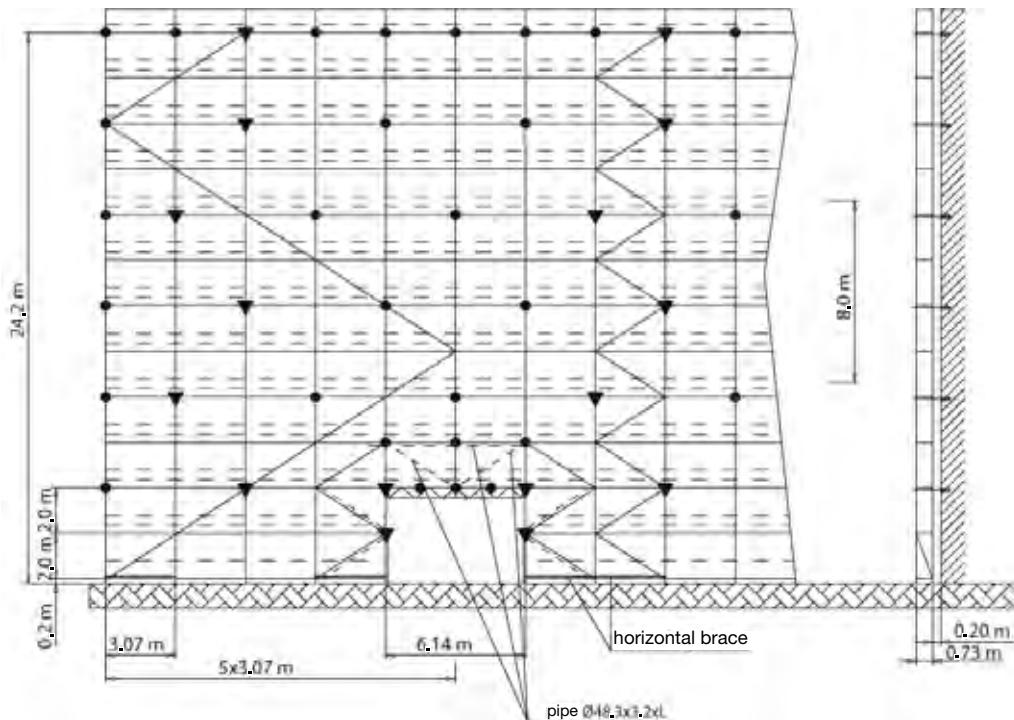

24.2 m

Scaffolding without covering, closed facade\*

Basic option

Working platform load of 2 kN/m<sup>2</sup>

Safety platform load of 1 kN/m<sup>2</sup>

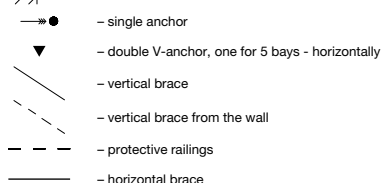
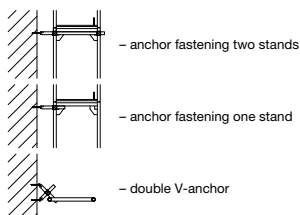

Type of facade filling	closed facade		
Vertical anchoring spacing	8 m		
Horizontal anchoring spacing	every second bay		
Maximum force in the anchor (kN)		2.8	
	⊥	4.2	
Maximum force in the foot (kN)	internal stand	14.0	15
	external stand	37.0	

\* closed facade, when number of openings is less than 20% of facade surface

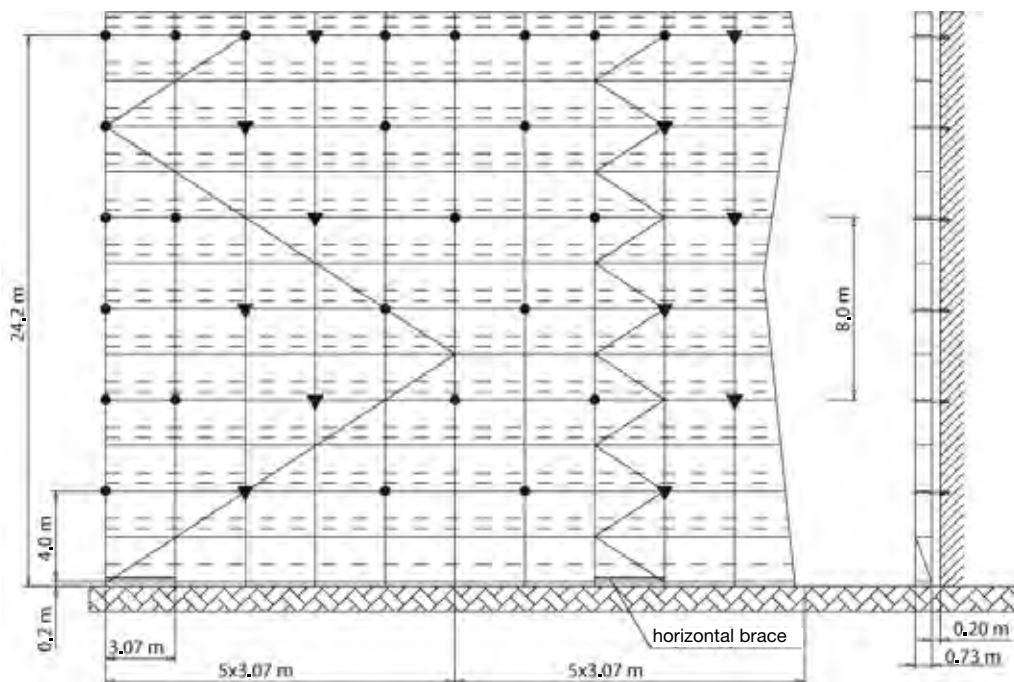

### WARNING:

Assembly manual does not substitute OHS rules at the construction site!  
Construction manager is responsible for proper scaffolding assembly and inspection!

24.2 m

Scaffolding without covering, closed facade\*  
 Working platform load of 2 kN/m<sup>2</sup>  
 Safety platform load of 1 kN/m<sup>2</sup>  
 Option: bracket 0.73 m – external, last level  
 + bracket 0.36 m – inside, all levels

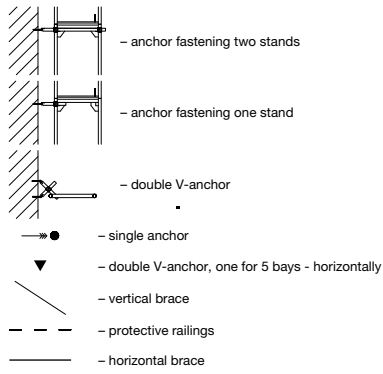

Type of facade filling	closed facade		
Vertical anchoring spacing	8 m		
Horizontal anchoring spacing	every second bay		
Maximum force in the anchor (kN)		2.8	
		4.1	
Maximum force in the foot (kN)	internal stand	24.3	17
	external stand	44.4	

\* closed facade, when number of openings is less than 20% of facade surface

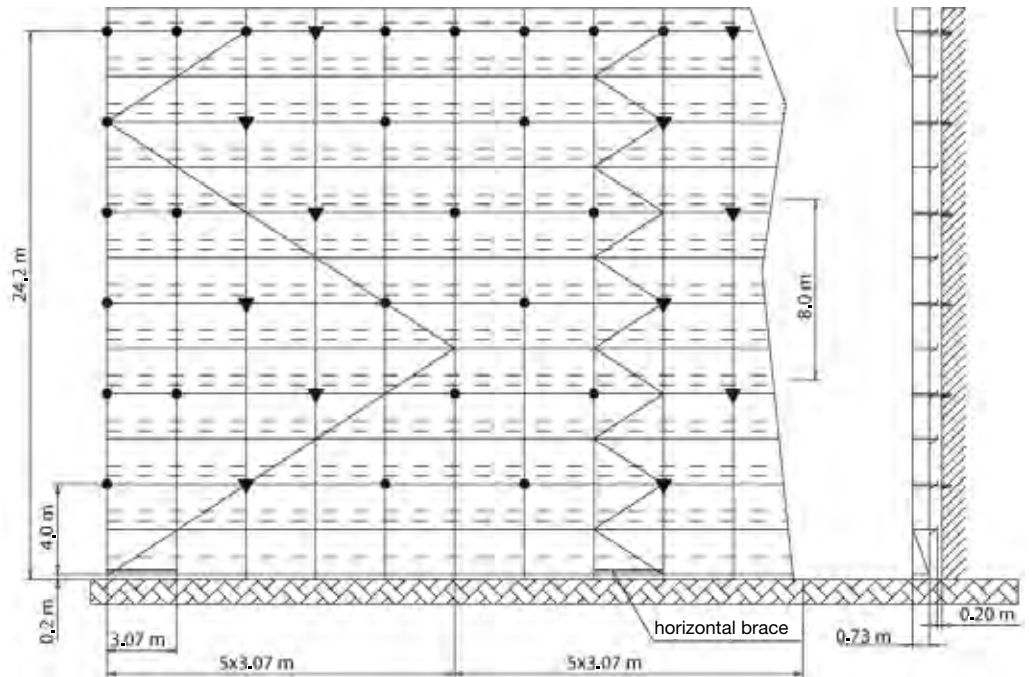

24.4 m

Scaffolding without covering, closed facade\*  
 Passage frame option  
 Working platform load of 2 kN/m<sup>2</sup>  
 Safety platform load of 1 kN/m<sup>2</sup>  
 Vertical brace on two levels, 2 for every 5 bays

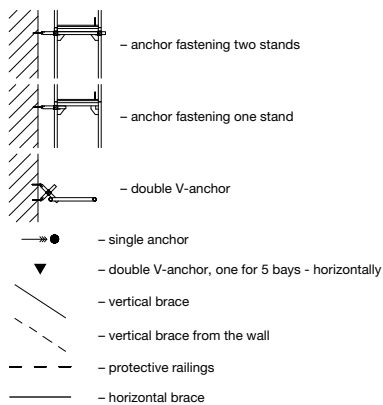

Type of facade filling	closed facade		
Vertical anchoring spacing	8 m		
Horizontal anchoring spacing	every second bay		
Maximum force in the anchor (kN)		2.6	
		4.2	
Maximum force in the foot (kN)	internal stand	21.3	19
	external stand	32.0	

\* closed facade, when number of openings is less than 20% of facade surface

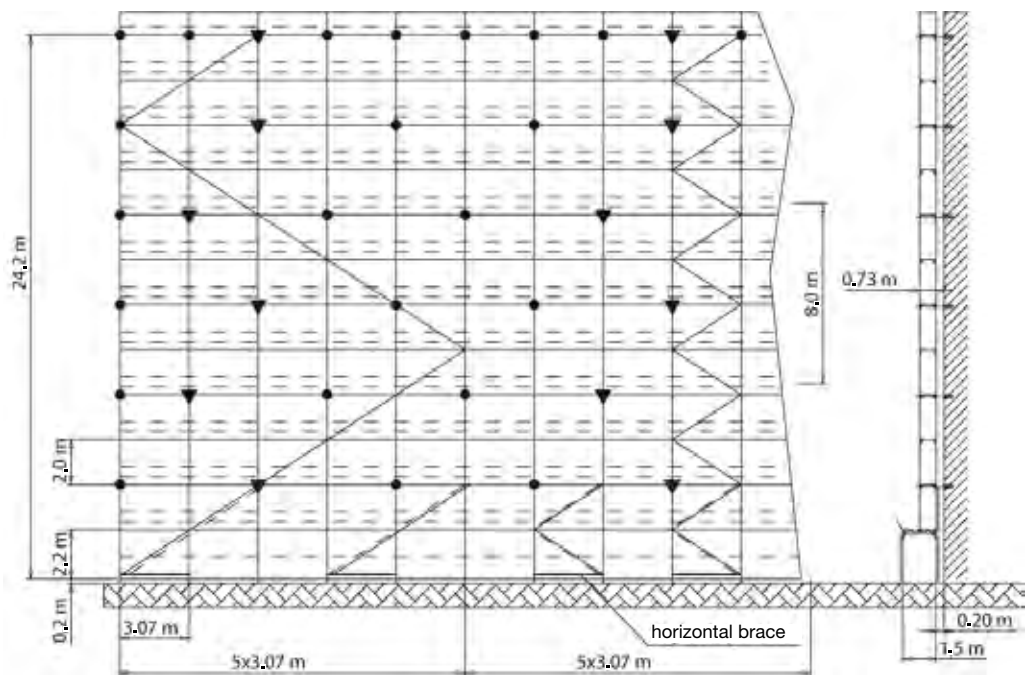

### WARNING:

Assembly manual does not substitute OHS rules at the construction site!  
 Construction manager is responsible for proper scaffolding assembly and inspection!

## 2. SCAFFOLDING ASSEMBLY UP TO 34 M HIGH

24.2 m

Scaffolding without covering, closed facade\*

Gate crossing option

Working platform load of 2 kN/m<sup>2</sup>

Safety platform load of 1 kN/m<sup>2</sup>

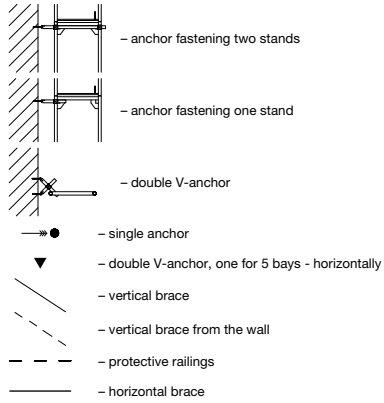

Type of facade filling	closed facade		
Vertical anchoring spacing	8 m		
Horizontal anchoring spacing	every second bay		
Maximum force in the anchor (kN)		3.2	
		4.3	
Maximum force in the foot (kN)	internal stand	25.9	28
	external stand	39.0	

\* closed facade, when number of openings is less than 20% of facade surface

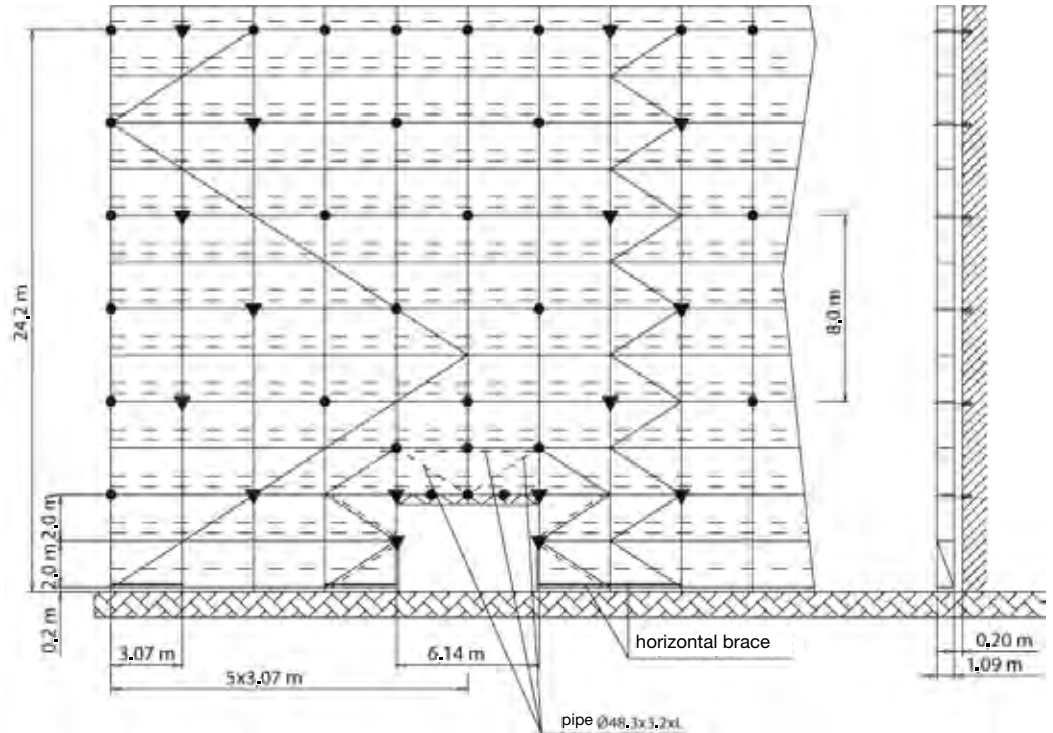

24.2 m

Scaffolding without covering, closed facade\*

Basic option

Working platform load of 2 kN/m<sup>2</sup>

Safety platform load of 1 kN/m<sup>2</sup>

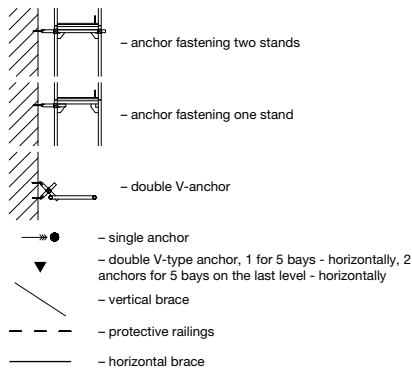

Type of facade filling	closed facade		
Vertical anchoring spacing	8 m		
Horizontal anchoring spacing	every second bay		
Maximum force in the anchor (kN)		2.8	
		4.3	
Maximum force in the foot (kN)	internal stand	18.0	29
	external stand	42.7	

\* closed facade, when number of openings is less than 20% of facade surface

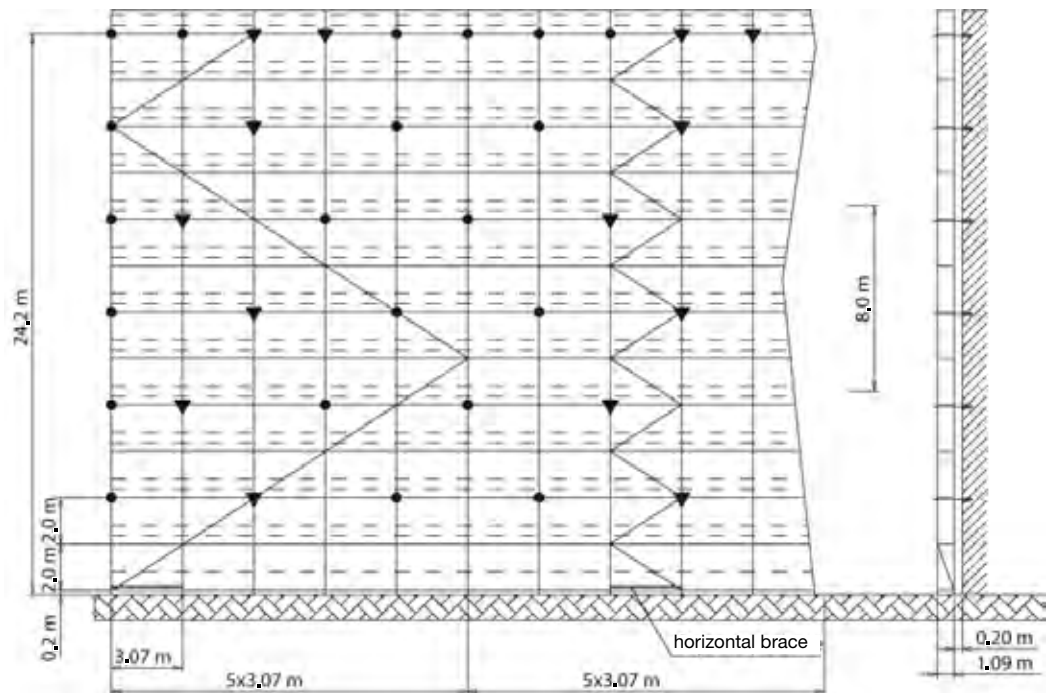

### WARNING:

Assembly manual does not substitute OHS rules at the construction site!  
Construction manager is responsible for proper scaffolding assembly and inspection!



24.2 m

Scaffolding without covering, closed facade\*  
 Working platform load of 2 kN/m<sup>2</sup>  
 Safety platform load of 1 kN/m<sup>2</sup>  
 Option: bracket 0.73 m – external, last level  
 + bracket 0.36 m – inside, all levels

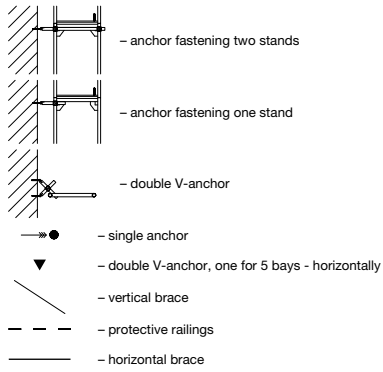

Type of facade filling	closed facade		
Vertical anchoring spacing	8 m		
Horizontal anchoring spacing	every second bay		
Maximum force in the anchor (kN)		2.8	30
		4.2	
Maximum force in the foot (kN)	internal stand	29.4	30
	external stand	50.1	

\* closed facade, when number of openings is less than 20% of facade surface

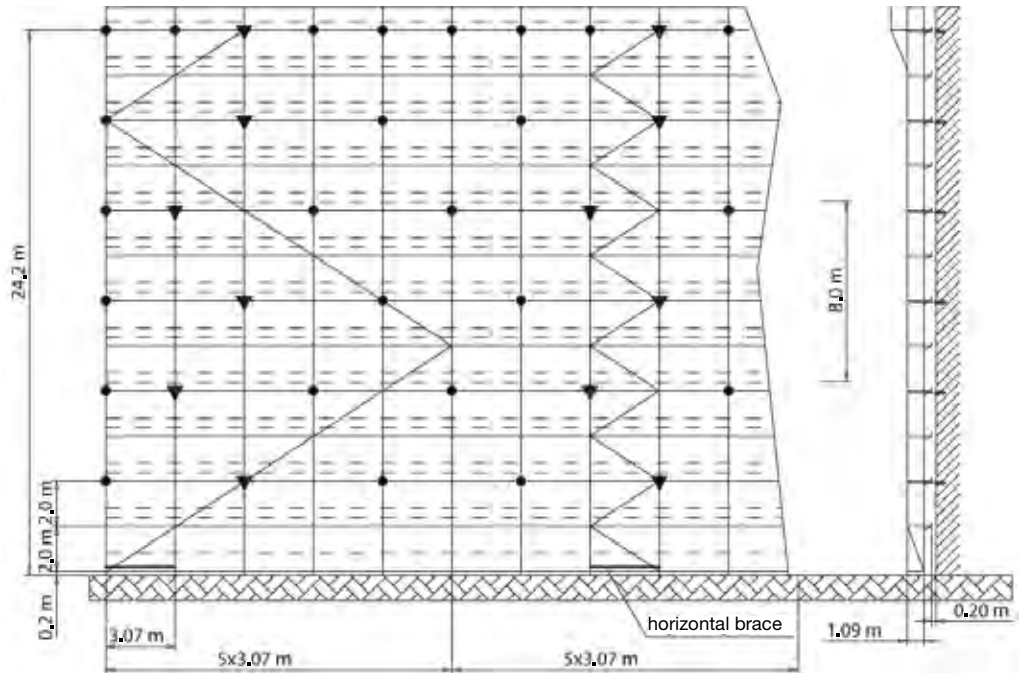

24.4 m

Scaffolding without covering, closed facade\*  
 Passage frame option  
 Working platform load of 2 kN/m<sup>2</sup>  
 Safety platform load of 1 kN/m<sup>2</sup>  
 Vertical brace on two levels, 2 for every 5 bays

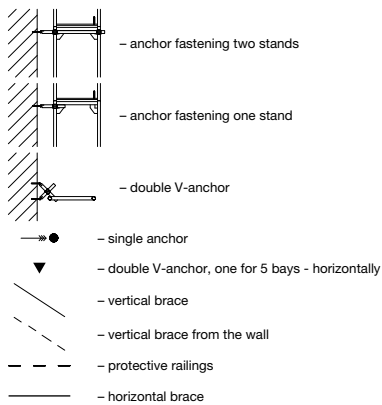

Type of facade filling	closed facade		
Vertical anchoring spacing	8 m		
Horizontal anchoring spacing	every second bay		
Maximum force in the anchor (kN)		3.0	31
		4.2	
Maximum force in the foot (kN)	internal stand	24.3	31
	external stand	34.6	

\* closed facade, when number of openings is less than 20% of facade surface

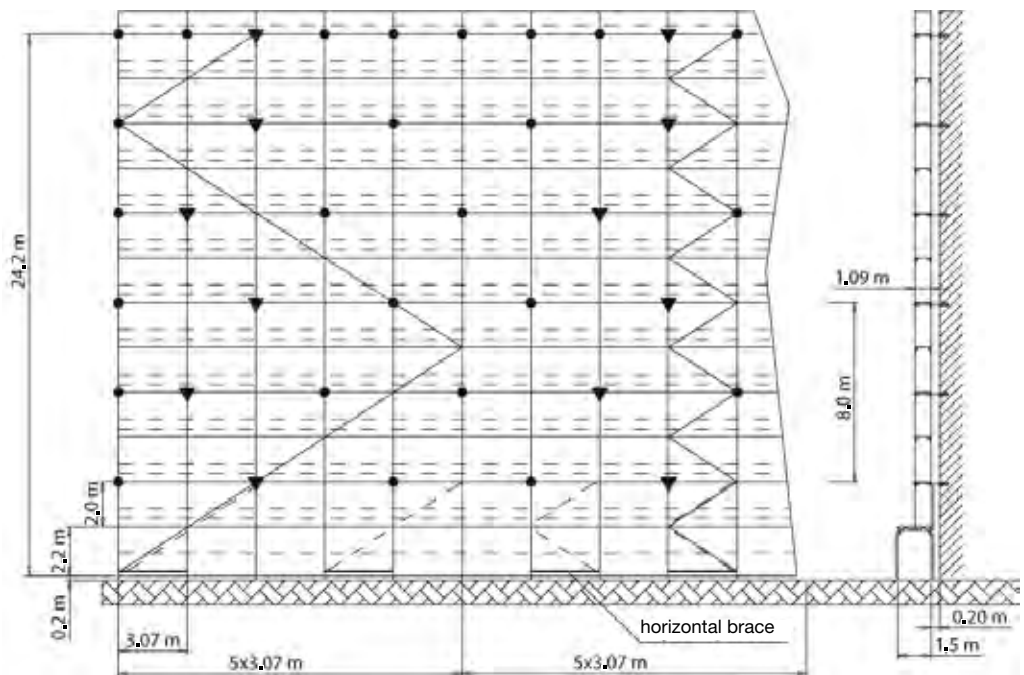

### WARNING:

Assembly manual does not substitute OHS rules at the construction site!  
 Construction manager is responsible for proper scaffolding assembly and inspection!

## 2. SCAFFOLDING ASSEMBLY UP TO 34 M HIGH

24.4 m

Scaffolding with covering, closed facade\*

Passage frame option

Working platform load of 2 kN/m<sup>2</sup>

Safety platform load of 1 kN/m<sup>2</sup>

Vertical brace on two levels, 2 for every 5 bays

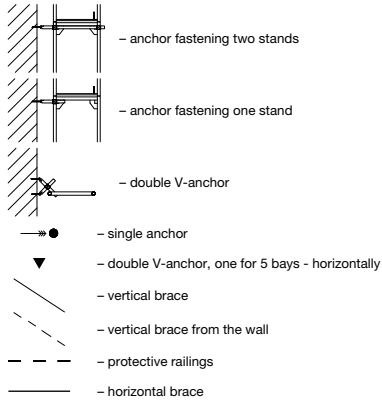

Type of facade filling	closed facade		
Vertical anchoring spacing	8 m		
Horizontal anchoring spacing	every second bay		
Maximum force in the anchor (kN)		2.8	
		2.6	
Maximum force in the foot (kN)	internal stand	31.2	32
	external stand	32.0	

\* closed facade, when number of openings is less than 20% of facade surface

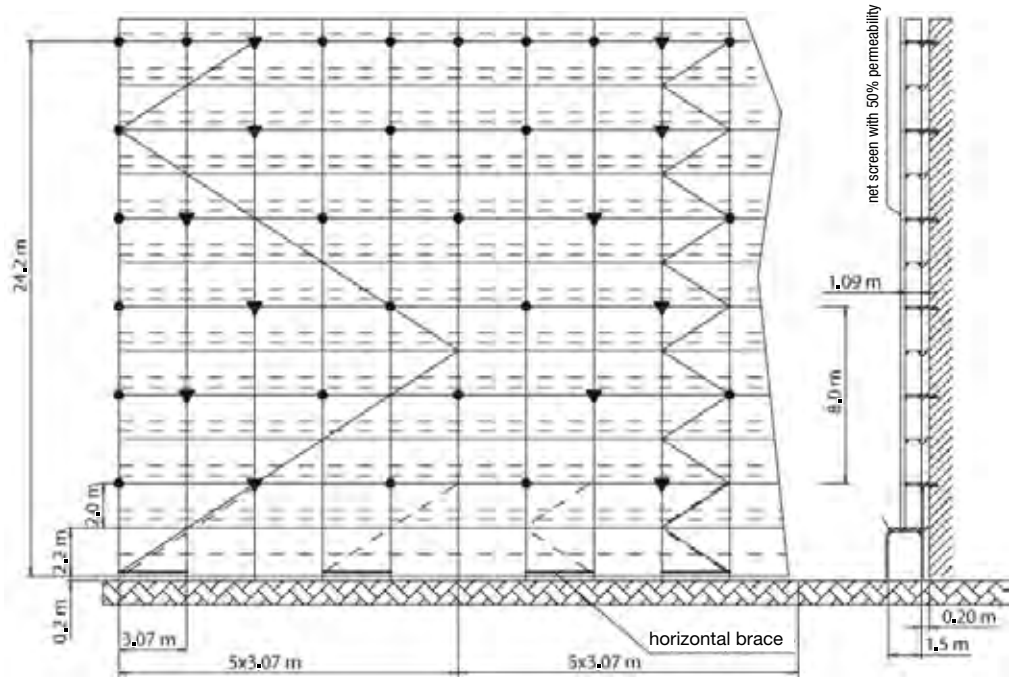

### 2.5.5. Braces and anchors arrangement for scaffolding shielded with net screen or canvas, up to 34 m high

34.2 m

Scaffolding with net screen, closed facade\*

Gate crossing option

Working platform load of 2 kN/m<sup>2</sup>

Safety platform load of 1 kN/m<sup>2</sup>

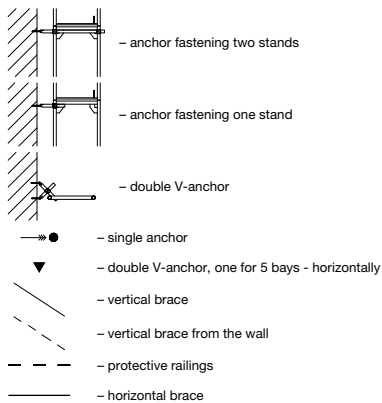

Type of facade filling	closed facade		
Vertical anchoring spacing	4 m		
Horizontal anchoring spacing	every second bay		
Maximum force in the anchor (kN)		2.2	
		3.0	
Maximum force in the foot (kN)	internal stand	22.2	02
	external stand	53.2	

\* closed facade, when number of openings is less than 20% of facade surface

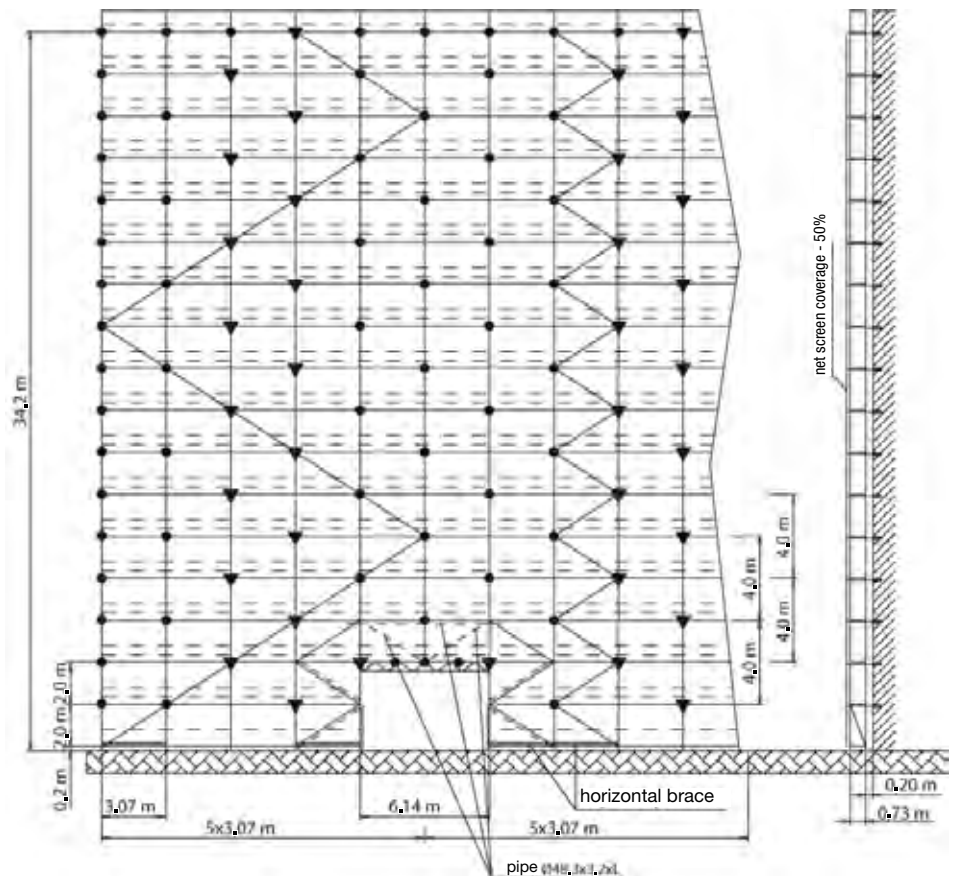

#### WARNING:

Assembly manual does not substitute OHS rules at the construction site!  
Construction manager is responsible for proper scaffolding assembly and inspection!

### Scaffolding with net screen, closed facade\*

Basic option

Working platform load of 2 kN/m<sup>2</sup>

Safety platform load of 1 kN/m<sup>2</sup>

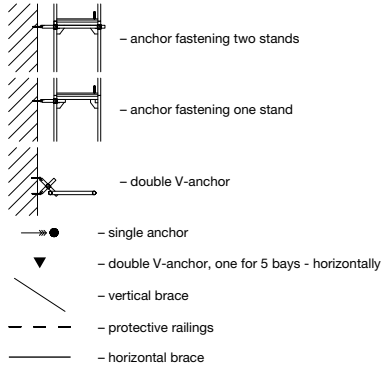

Type of facade filling	closed facade		
Vertical anchoring spacing	4 m		
Horizontal anchoring spacing	every second bay		
Maximum force in the anchor (kN)		3.9	04
		3.0	
Maximum force in the foot (kN)	internal stand	16.3	04
	external stand	53.7	

\* closed facade, when number of openings is less than 20% of facade surface

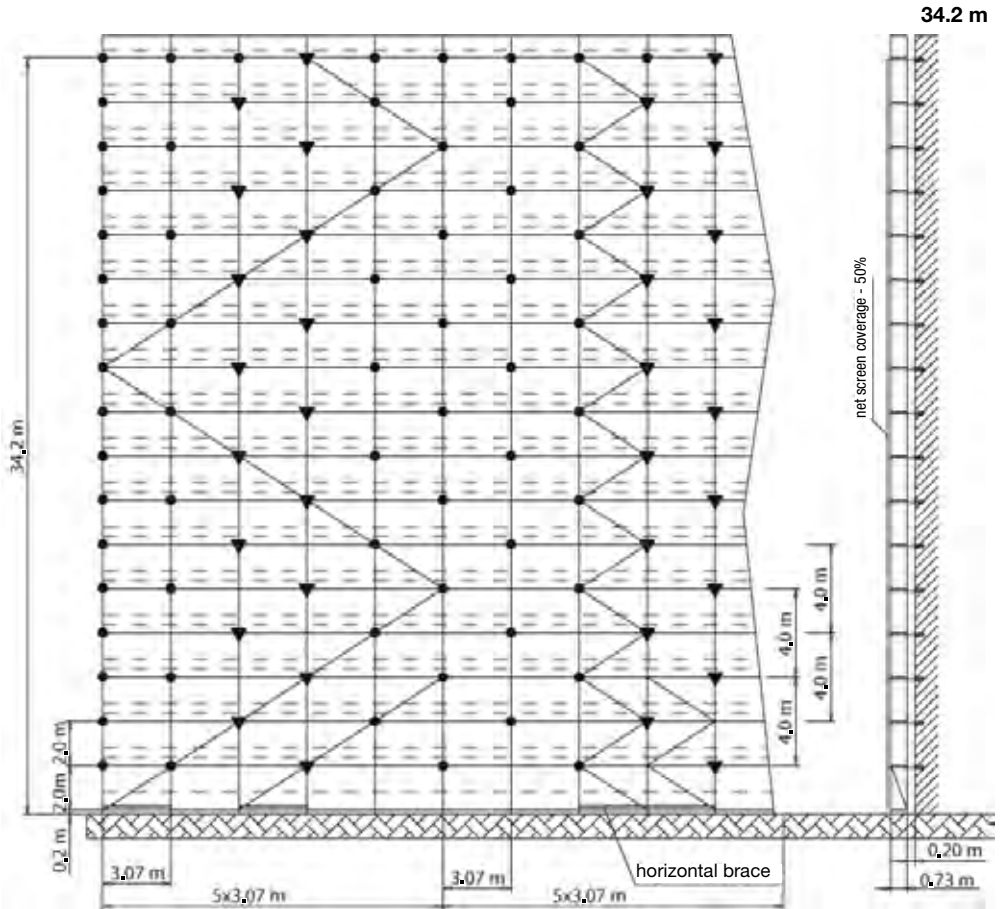

### Scaffolding with net screen, closed facade\*

Working platform load of 2 kN/m<sup>2</sup>

Safety platform load of 1 kN/m<sup>2</sup>

Option: bracket 0.73 m – external, last level

+ bracket 0.36 m – inside, all levels

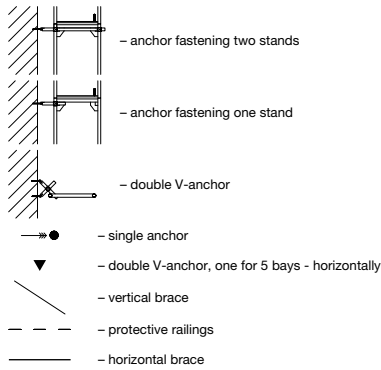

Type of facade filling	closed facade		
Vertical anchoring spacing	4 m		
Horizontal anchoring spacing	every second bay		
Maximum force in the anchor (kN)		3.1	06
		3.0	
Maximum force in the foot (kN)	internal stand	29.3	06
	external stand	61.2	

\* closed facade, when number of openings is less than 20% of facade surface

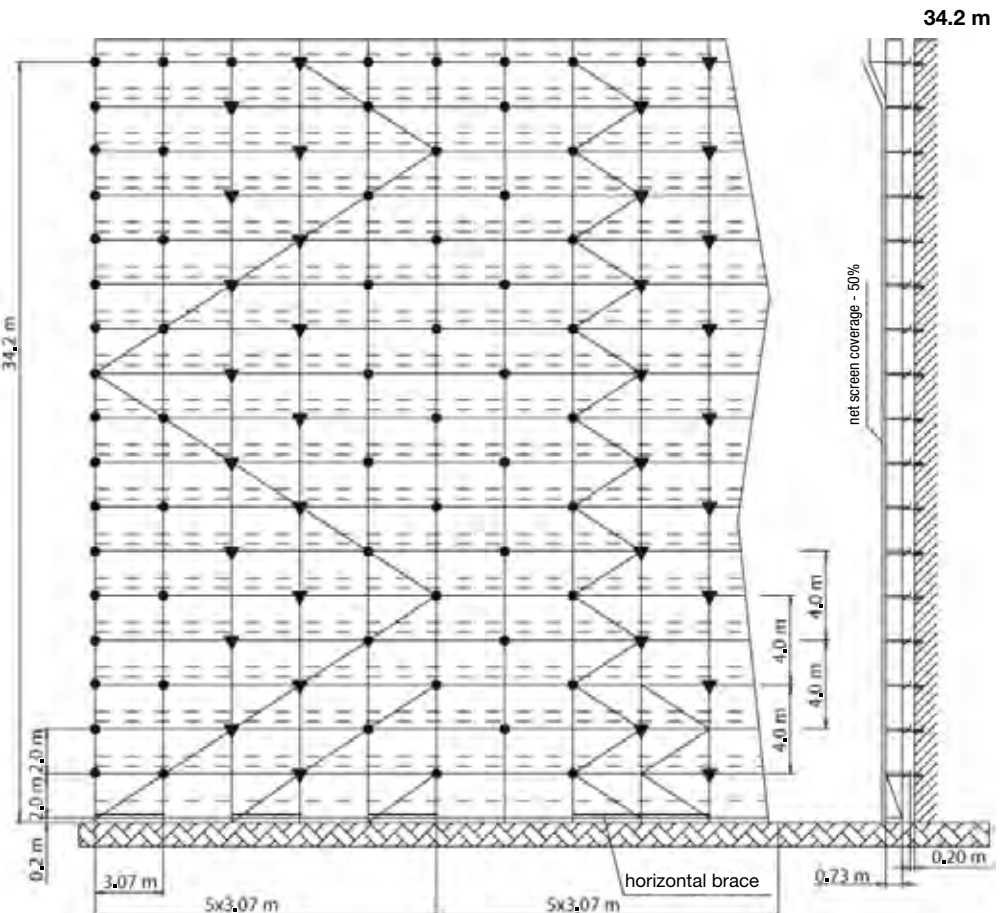

### WARNING:

Assembly manual does not substitute OHS rules at the construction site!  
Construction manager is responsible for proper scaffolding assembly and inspection!



# FRAME SCAFFOLDINGS – ASSEMBLY MANUAL

## 2. SCAFFOLDING ASSEMBLY UP TO 34 M HIGH

Scaffolding with net screen, closed facade\*

Passage frame option

Working platform load of 2 kN/m<sup>2</sup>

Safety platform load of 1 kN/m<sup>2</sup>

Vertical brace on two levels, 2 for every 5 bays

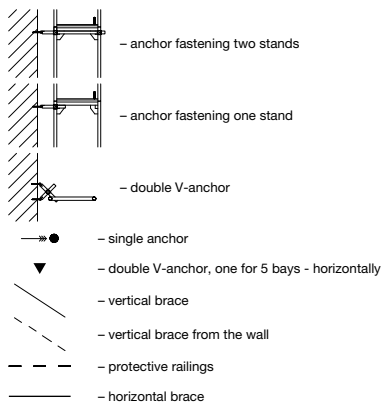

Type of facade filling	closed facade		
Vertical anchoring spacing	4 m		
Horizontal anchoring spacing	every second bay		
Maximum force in the anchor (kN)		5.1	08
		3.7	
Maximum force in the foot (kN)	internal stand	25.5	08
	external stand	32.7	

\* closed facade, when number of openings is less than 20% of facade surface

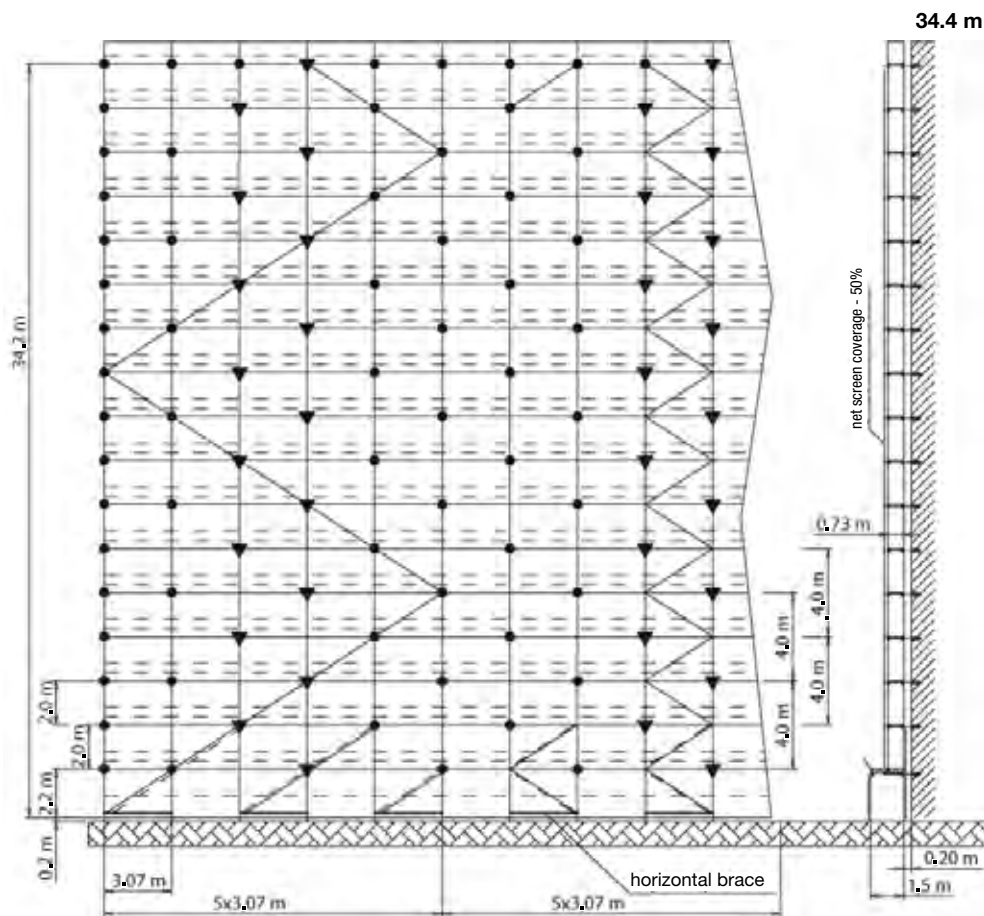

24.2 m

Scaffolding with net screen, closed facade\*

Gate crossing option

Working platform load of 2 kN/m<sup>2</sup>

Safety platform load of 1 kN/m<sup>2</sup>

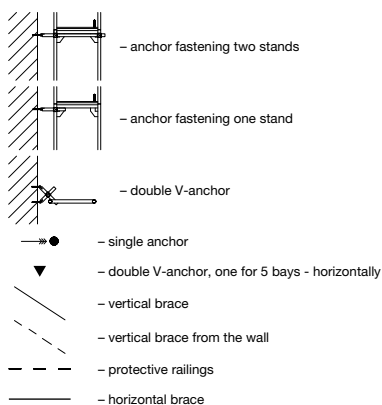

Type of facade filling	closed facade		
Vertical anchoring spacing	4 m		
Horizontal anchoring spacing	every second bay		
Maximum force in the anchor (kN)		2.7	14
		2.6	
Maximum force in the foot (kN)	internal stand	17.6	14
	external stand	34.4	

\* closed facade, when number of openings is less than 20% of facade surface

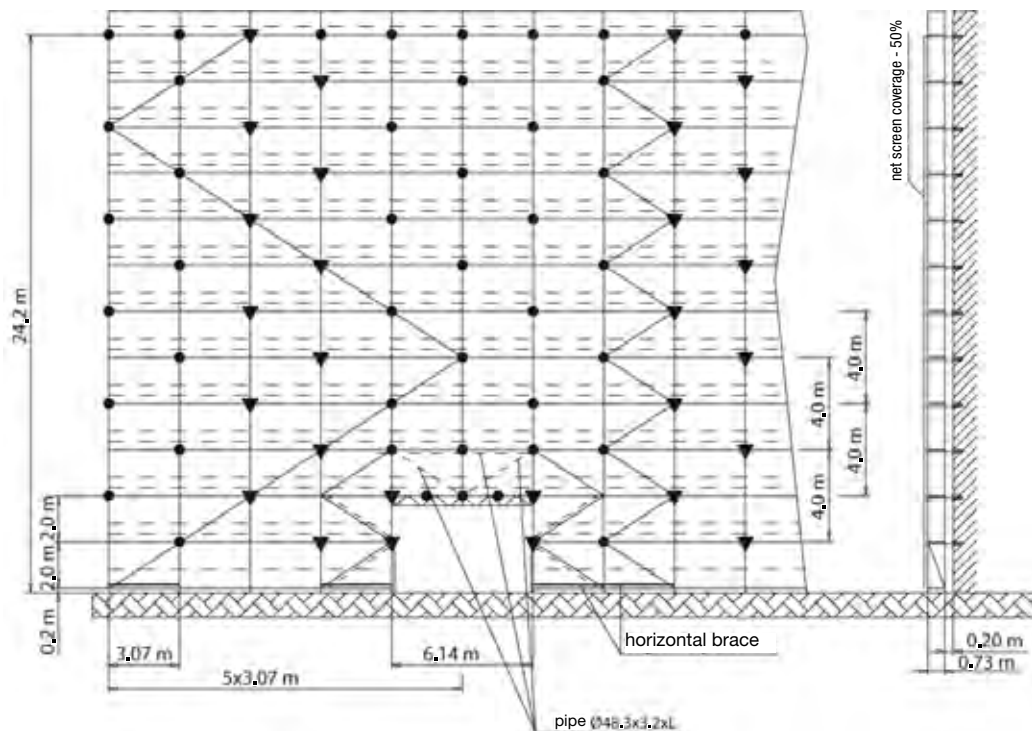

### WARNING:

Assembly manual does not substitute OHS rules at the construction site!  
Construction manager is responsible for proper scaffolding assembly and inspection!



24.2 m

Scaffolding with net screen, closed facade\*

Basic option

Working platform load of 2 kN/m<sup>2</sup>

Safety platform load of 1 kN/m<sup>2</sup>

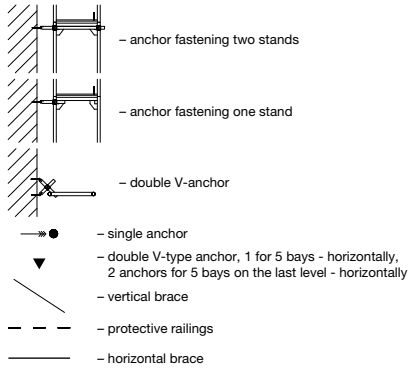

Type of facade filling	closed facade		
Vertical anchoring spacing	4 m		
Horizontal anchoring spacing	every second bay		
Maximum force in the anchor (kN)		2.7	
	⊥	2.6	
Maximum force in the foot (kN)	internal stand	12.7	16
	external stand	37.3	

\* closed facade, when number of openings is less than 20% of facade surface

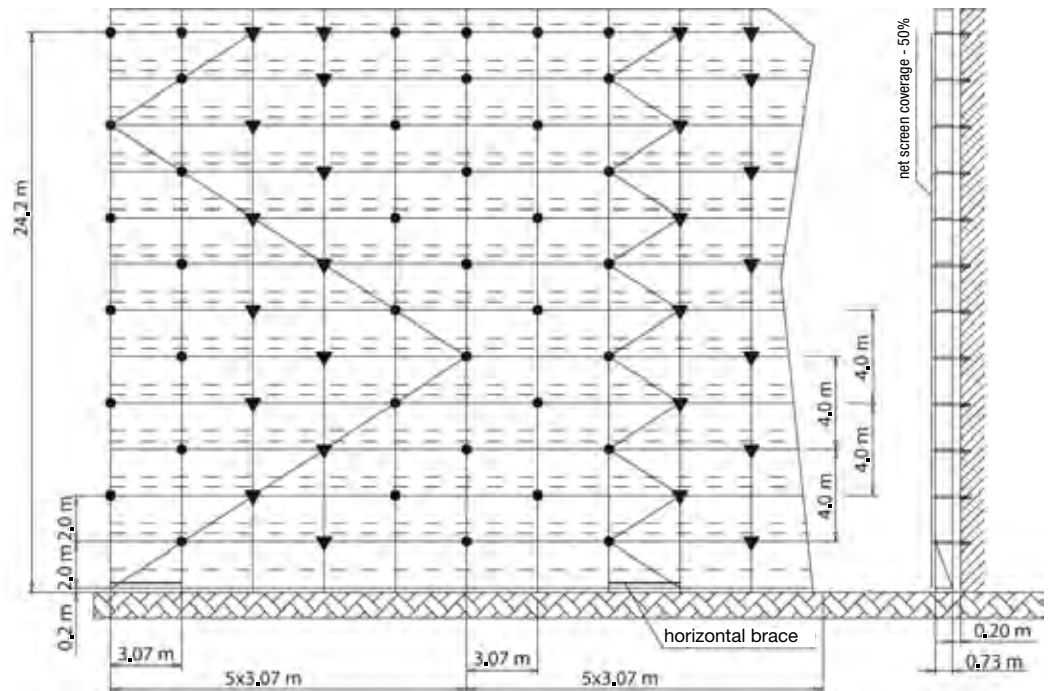

24.2 m

Scaffolding with net screen, closed facade\*

Working platform load of 2 kN/m<sup>2</sup>

Safety platform load of 1 kN/m<sup>2</sup>

Option: bracket 0.73 m – external, last level

+ bracket 0.36 m – inside, all levels

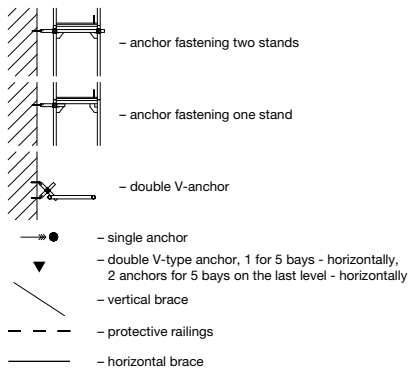

Type of facade filling	closed facade		
Vertical anchoring spacing	8 m		
Horizontal anchoring spacing	every second bay		
Maximum force in the anchor (kN)		2.8	
	⊥	2.6	
Maximum force in the foot (kN)	internal stand	23.3	18
	external stand	43.5	

\* closed facade, when number of openings is less than 20% of facade surface

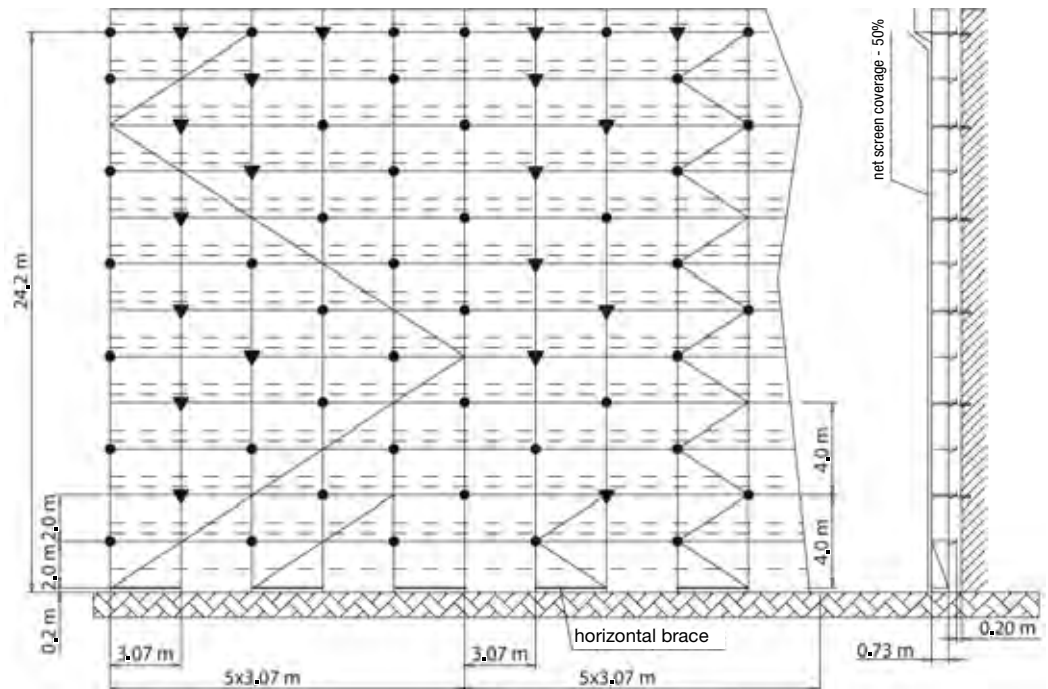

### WARNING:

Assembly manual does not substitute OHS rules at the construction site!  
Construction manager is responsible for proper scaffolding assembly and inspection!

## 2. SCAFFOLDING ASSEMBLY UP TO 34 M HIGH

24.4 m

Scaffolding with net screen, closed facade\*

Passage frame option

Working platform load of 2 kN/m<sup>2</sup>

Safety platform load of 1 kN/m<sup>2</sup>

Vertical brace on two levels, 2 for every 5 bays

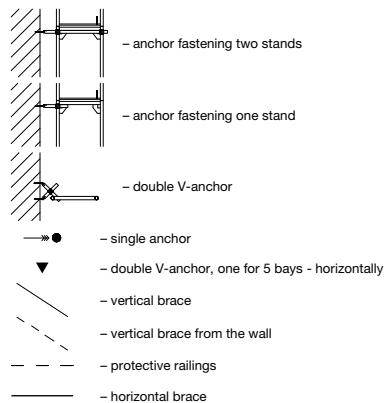

Type of facade filling	closed facade		
Vertical anchoring spacing	4 m		
Horizontal anchoring spacing	every second bay		
Maximum force in the anchor (kN)		2.8	
		2.6	
Maximum force in the foot (kN)	internal stand	20.4	20
	external stand	32.0	

\* closed facade, when number of openings is less than 20% of facade surface

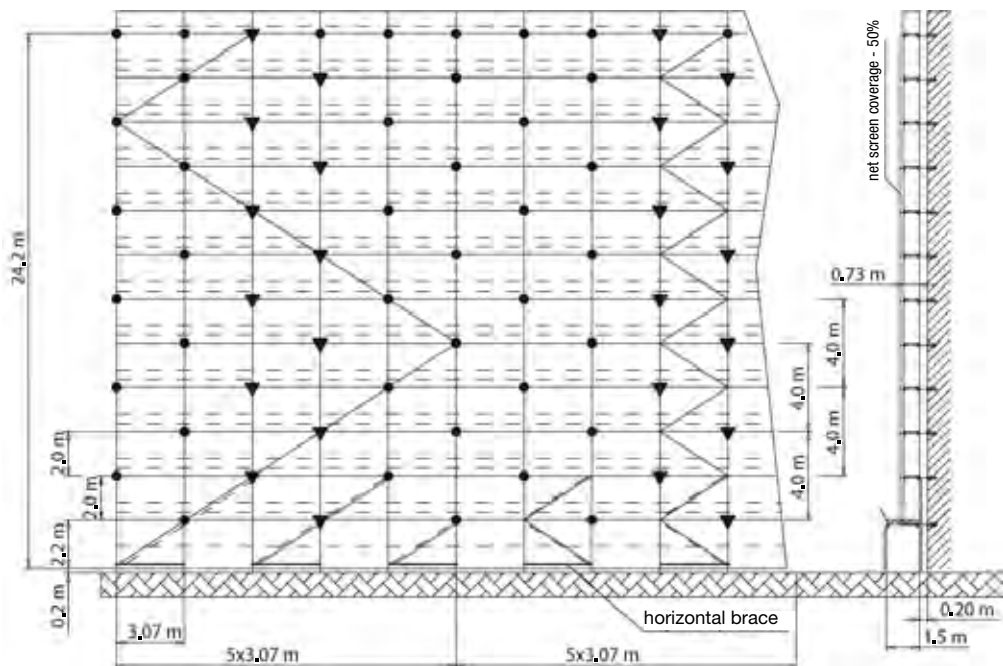

24.2 m

Scaffolding with net screen, semi-open facade\*

Gate crossing option

Working platform load of 2 kN/m<sup>2</sup>

Safety platform load of 1 kN/m<sup>2</sup>

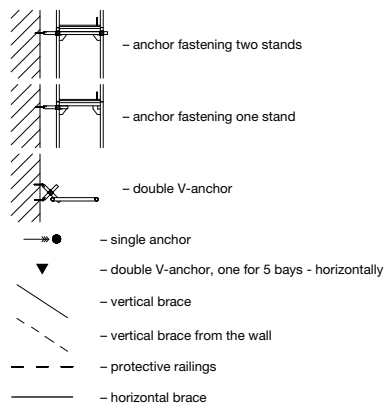

Type of facade filling	semi-open facade		
Vertical anchoring spacing	4 m		
Horizontal anchoring spacing	every second bay		
Maximum force in the anchor (kN)		2.7	
		2.8	
Maximum force in the foot (kN)	internal stand	17.6	21
	external stand	35.1	

\* semi-open facade, when the number of openings in the facade is within the range of 0% to 60%

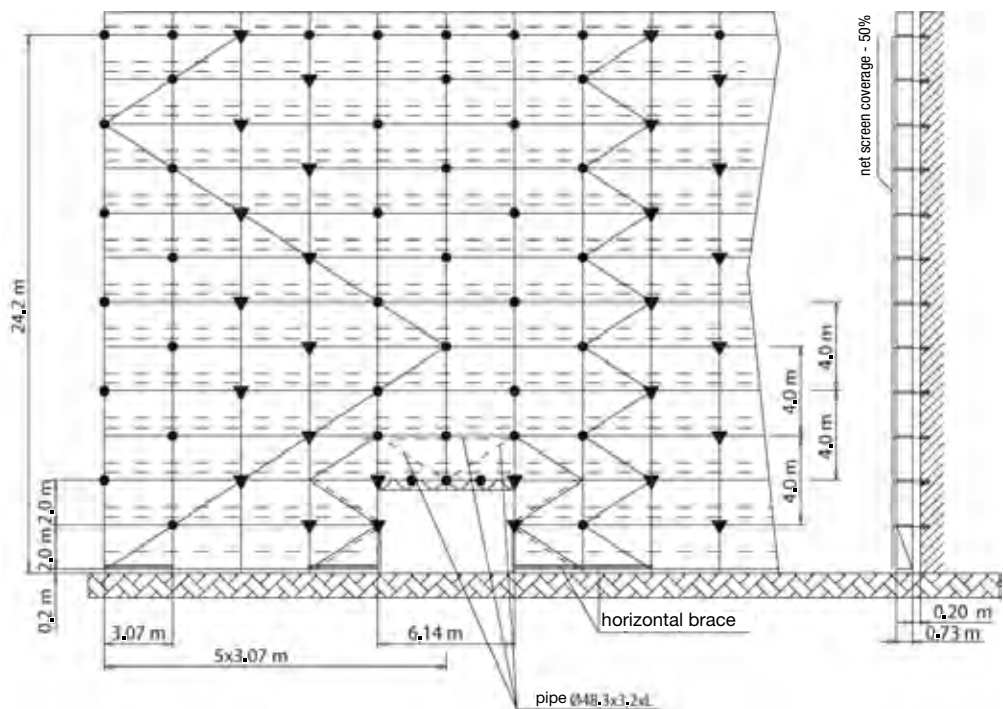

### WARNING:

Assembly manual does not substitute OHS rules at the construction site!  
Construction manager is responsible for proper scaffolding assembly and inspection!

24.2 m

Scaffolding with net screen, semi-open facade\*

Basic option

Working platform load of 2 kN/m<sup>2</sup>

Safety platform load of 1 kN/m<sup>2</sup>

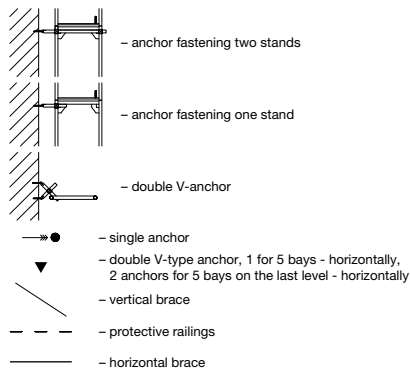

Type of facade filling	semi-open facade	
Vertical anchoring spacing	4 m	
Horizontal anchoring spacing	every second bay	
Maximum force in the anchor (kN)		2.8
		2.9
Maximum force in the foot (kN)	internal stand	12.5
	external stand	37.1
		22

\* semi-open facade, when the number of openings in the facade is within the range of 0% to 60%

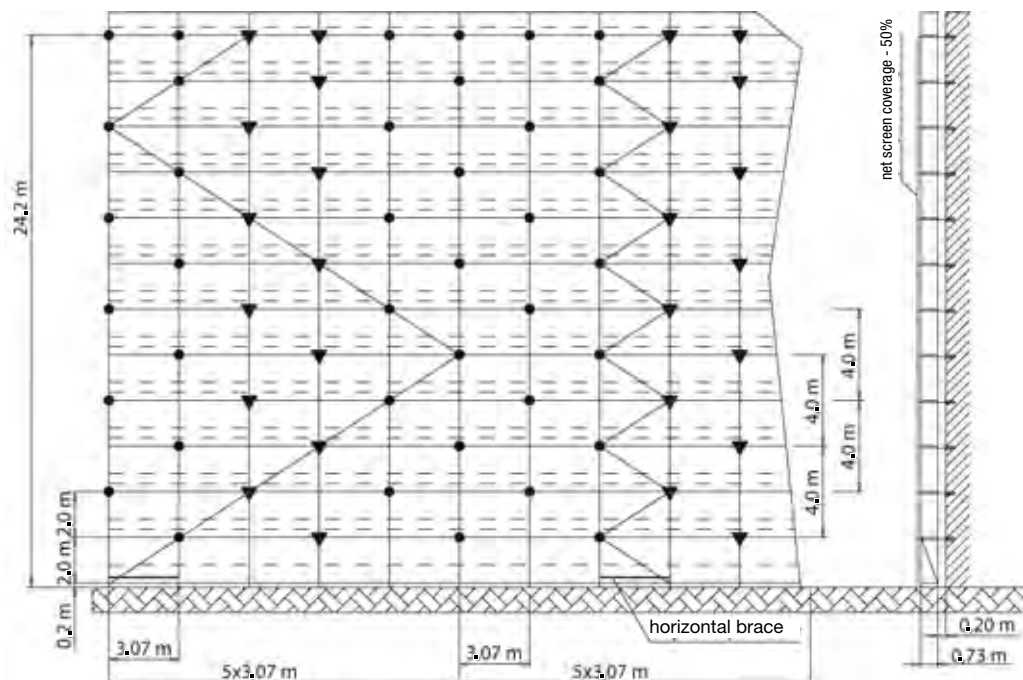

24.2 m

Scaffolding with net screen, semi-open facade\*

Working platform load of 2 kN/m<sup>2</sup>

Safety platform load of 1 kN/m<sup>2</sup>

Option: bracket 0.73 m – external, last level

+ bracket 0.36 m – inside, all levels

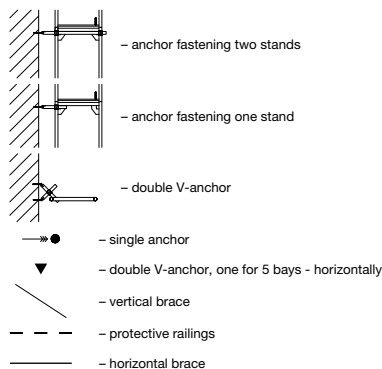

Type of facade filling	semi-open facade	
Vertical anchoring spacing	4 m	
Horizontal anchoring spacing	every second bay	
Maximum force in the anchor (kN)		2.8
		2.9
Maximum force in the foot (kN)	internal stand	23.3
	external stand	43.5
		23

\* semi-open facade, when the number of openings in the facade is within the range of 0% to 60%

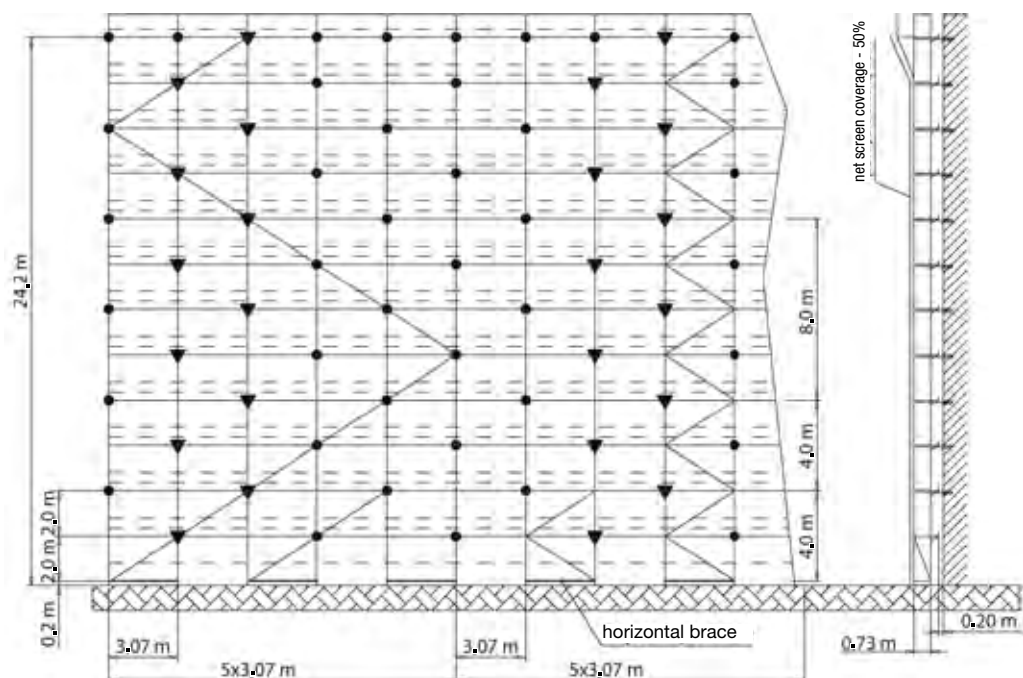

### WARNING:

Assembly manual does not substitute OHS rules at the construction site!  
Construction manager is responsible for proper scaffolding assembly and inspection!



## 2. SCAFFOLDING ASSEMBLY UP TO 34 M HIGH

24.4 m

Scaffolding with net screen, semi-open facade\*  
 Passage frame option  
 Working platform load of 2 kN/m<sup>2</sup>  
 Safety platform load of 1 kN/m<sup>2</sup>  
 Vertical brace on two levels, 2 for every 5 bays

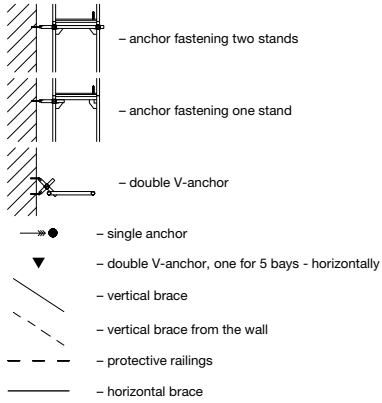

Type of facade filling	semi-open facade		
Vertical anchoring spacing	4 m		
Horizontal anchoring spacing	every second bay		
Maximum force in the anchor (kN)		2.8	
		2.9	
Maximum force in the foot (kN)	internal stand	20.4	24
	external stand	32.0	

\* semi-open facade, when the number of openings in the facade is within the range of 0% to 60%

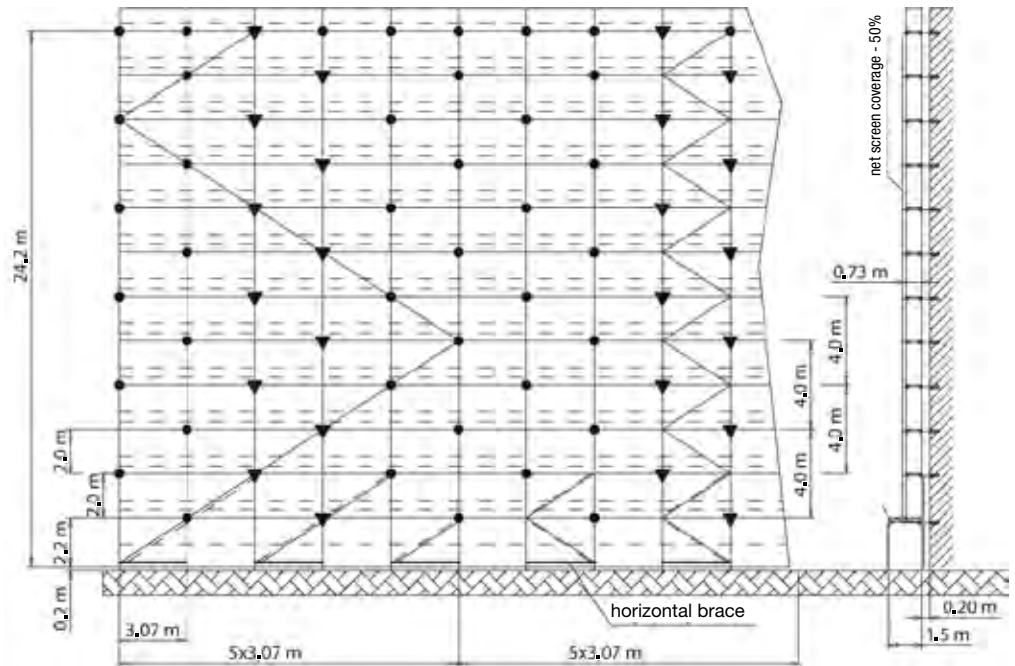

24.2 m

Scaffolding with canvas, closed facade\*  
 Gate crossing option  
 Working platform load of 2 kN/m<sup>2</sup>  
 Safety platform load of 1 kN/m<sup>2</sup>

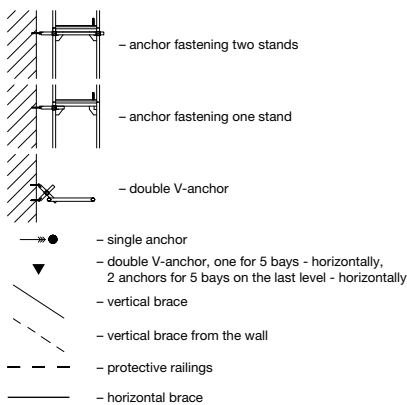

Type of facade filling	closed facade		
Vertical anchoring spacing	each node		
Horizontal anchoring spacing	each node		
Maximum force in the anchor (kN)		1.65	
		2.9	
Maximum force in the foot (kN)	internal stand	18.0	25
	external stand	35.4	

\* closed facade, when number of openings is less than 20% of facade surface

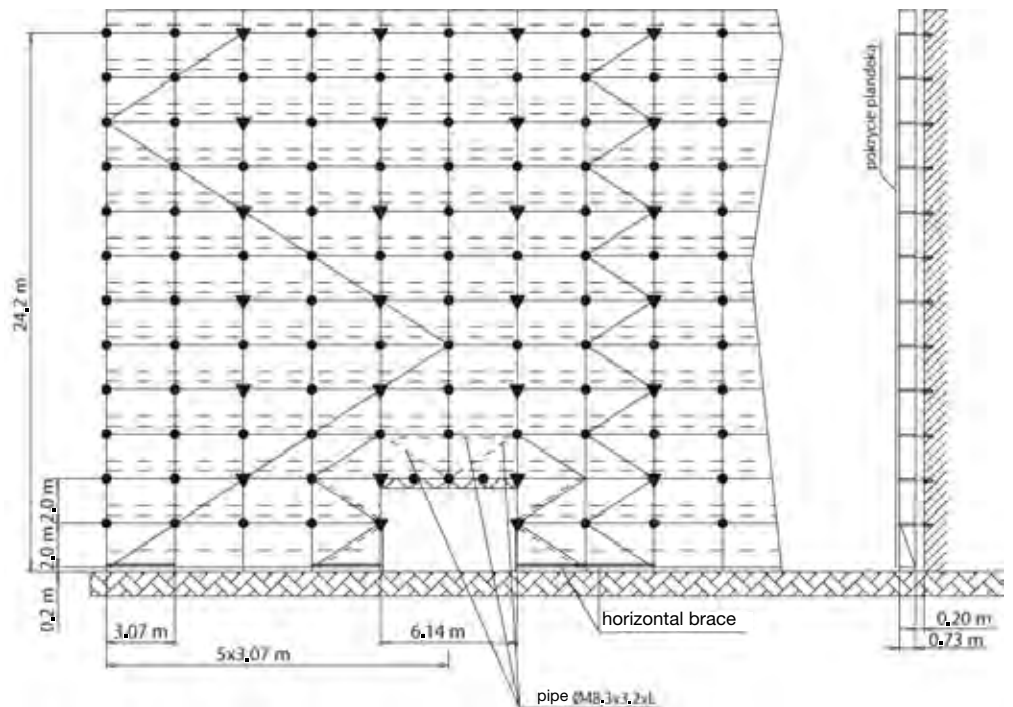

### WARNING:

Assembly manual does not substitute OHS rules at the construction site!  
 Construction manager is responsible for proper scaffolding assembly and inspection!



24.2 m

Scaffolding with canvas, closed facade\*

Basic option

Working platform load of 2 kN/m<sup>2</sup>

Safety platform load of 1 kN/m<sup>2</sup>

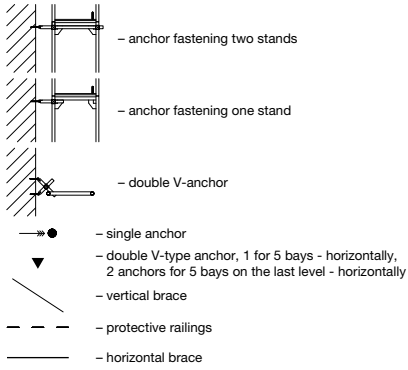

Type of facade filling	closed facade		
Vertical anchoring spacing	each node		
Horizontal anchoring spacing	each node		
Maximum force in the anchor (kN)		1.6	
		2.9	
Maximum force in the foot (kN)	internal stand	13.2	26
	external stand	36.9	

\* closed facade, when number of openings is less than 20% of facade surface

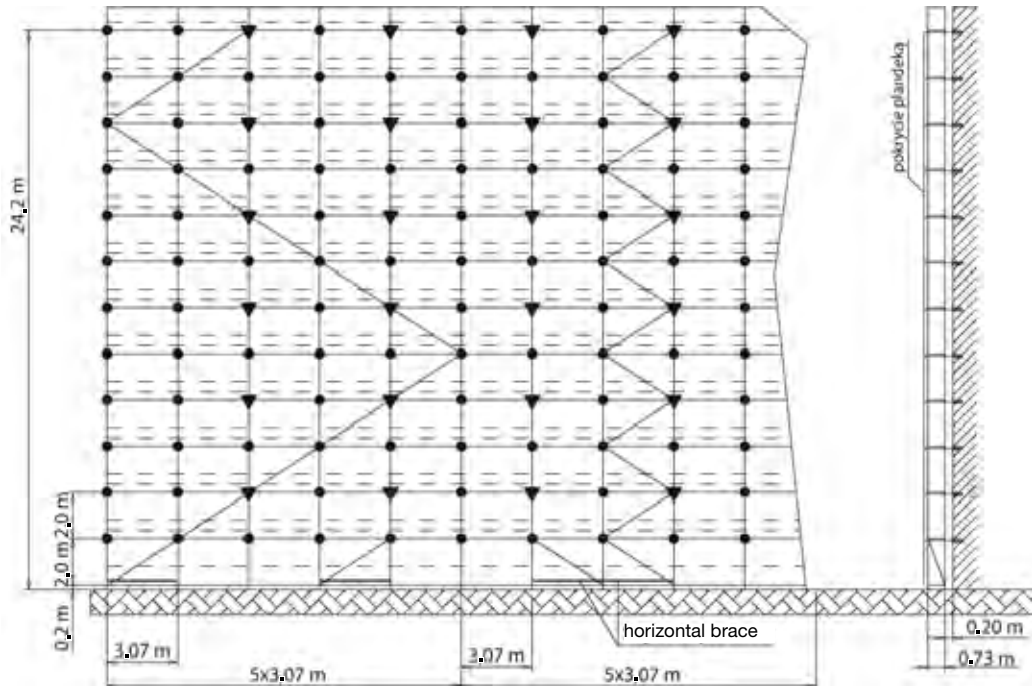

24.2 m

Scaffolding with canvas, closed facade\*

Working platform load of 2 kN/m<sup>2</sup>

Safety platform load of 1 kN/m<sup>2</sup>

Bracket 0.36 m – inside, all levels

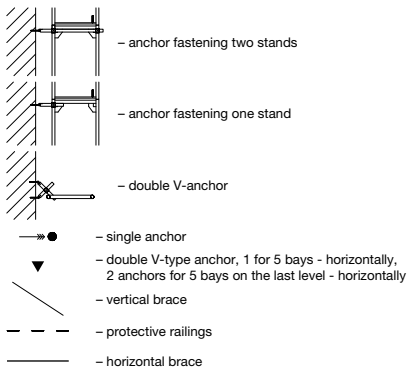

Type of facade filling	closed facade		
Vertical anchoring spacing	each node		
Horizontal anchoring spacing	each node		
Maximum force in the anchor (kN)		1.6	
		3.0	
Maximum force in the foot (kN)	internal stand	23.5	27
	external stand	36.9	

\* closed facade, when number of openings is less than 20% of facade surface

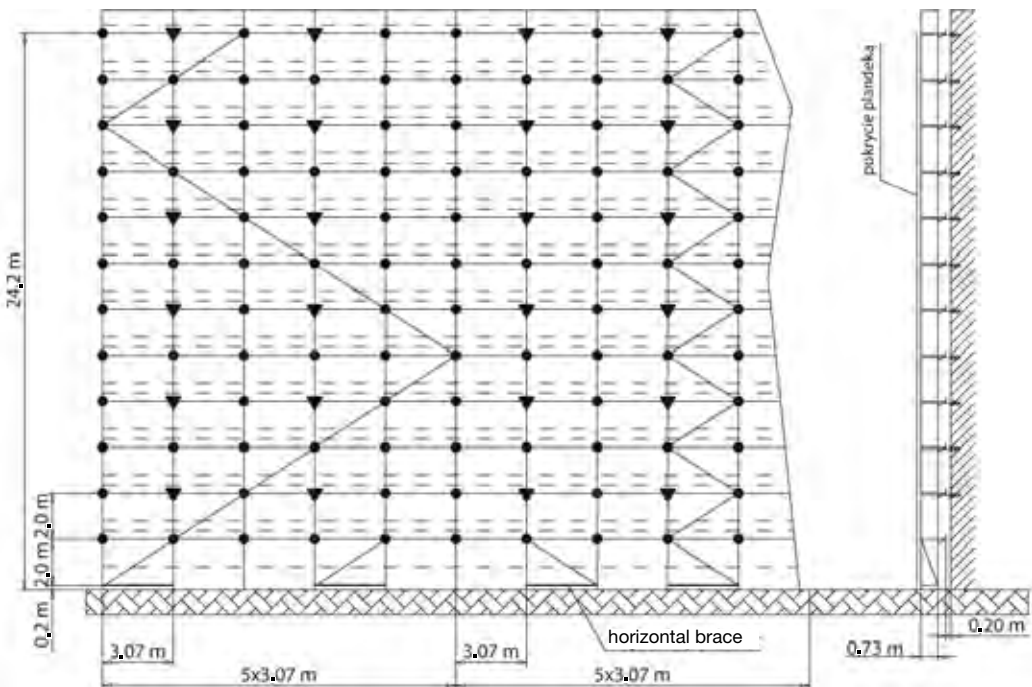

### WARNING:

Assembly manual does not substitute OHS rules at the construction site!  
Construction manager is responsible for proper scaffolding assembly and inspection!

## 2. SCAFFOLDING ASSEMBLY UP TO 34 M HIGH

### 2.5.6. Additional anchors during girder assembly

Permissible workload of 2 kN/m<sup>2</sup>.  
 Bracket 0.36 m (e285539) at the wall side.  
 Permissible level of footing unscrewing – 0.2 m.

Permissible workload of 2 kN/m<sup>2</sup>.  
 Bracket 0.36 m (e285539) at the wall side.  
 Permissible level of footing unscrewing – 0.2 m.

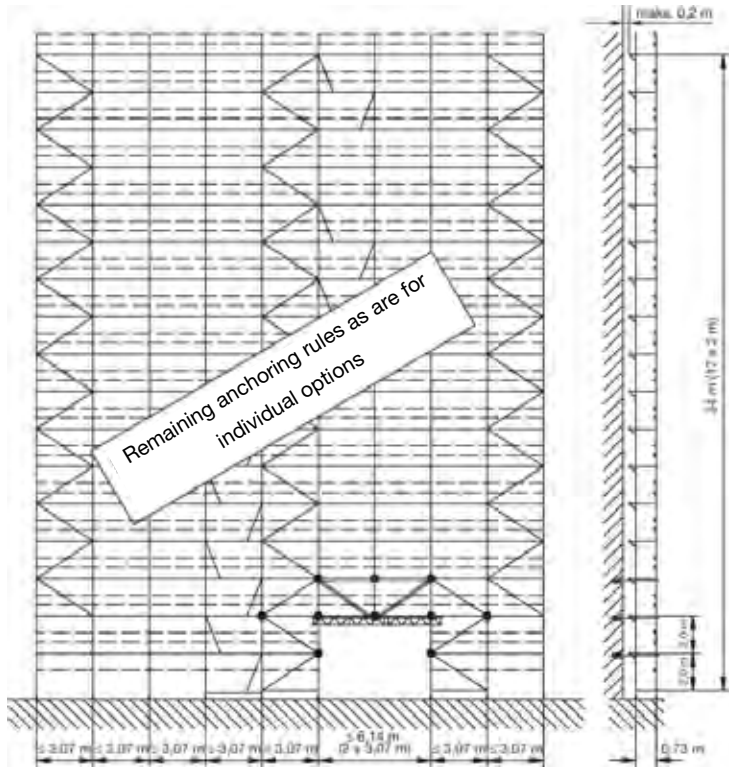

Fig. 2.33 – Forces present in anchor in individual options

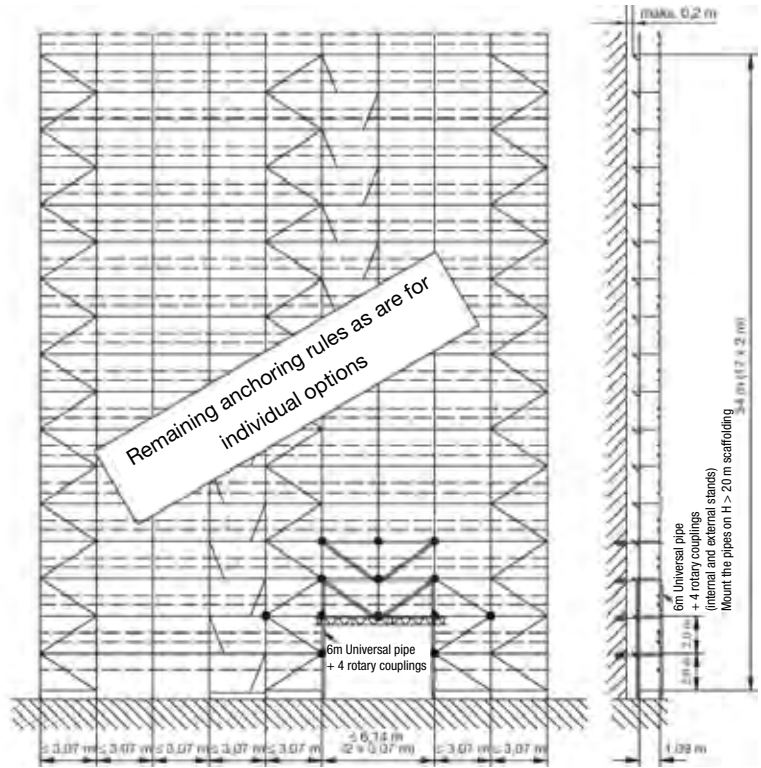

Fig. 2.34 – Forces present in anchor in individual options

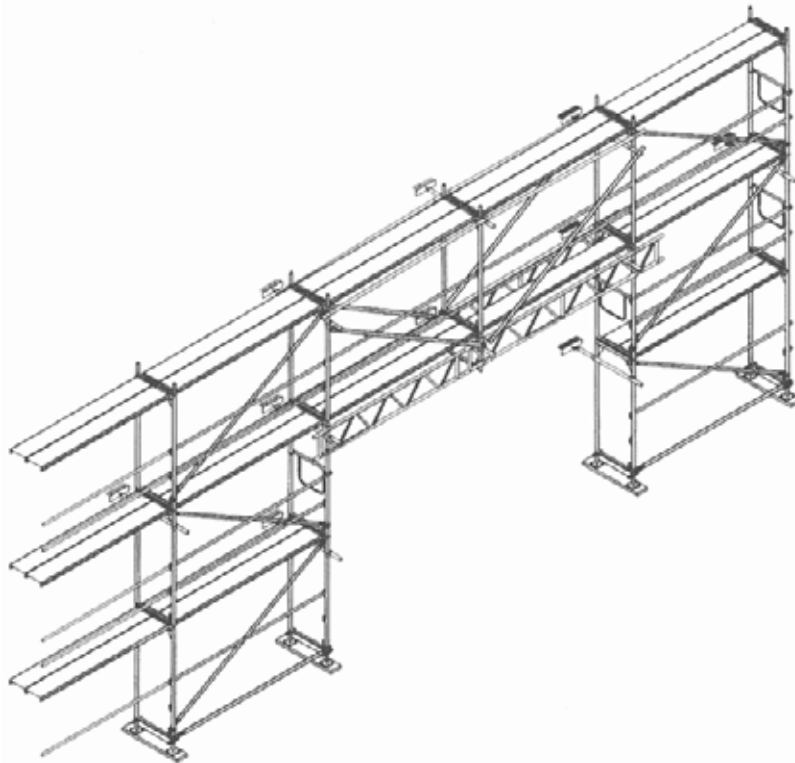

Fig. 2.10 – Axonometric view of exemplary gate crossing

**WARNING:**

Assembly manual does not substitute OHS rules at the construction site!  
 Construction manager is responsible for proper scaffolding assembly and inspection!

2.5.7. Additional anchors during protective canopy and passage frames installation

Permissible workload of 2 kN/m<sup>2</sup>.  
Bracket 0.36 m (e285539) at the wall side.  
Permissible level of footing unscrewing – 0.2 m.

Permissible workload of 2 kN/m<sup>2</sup>.  
Bracket 0.36 m (e285539) at the wall side.  
Permissible level of footing unscrewing – 0.2 m.

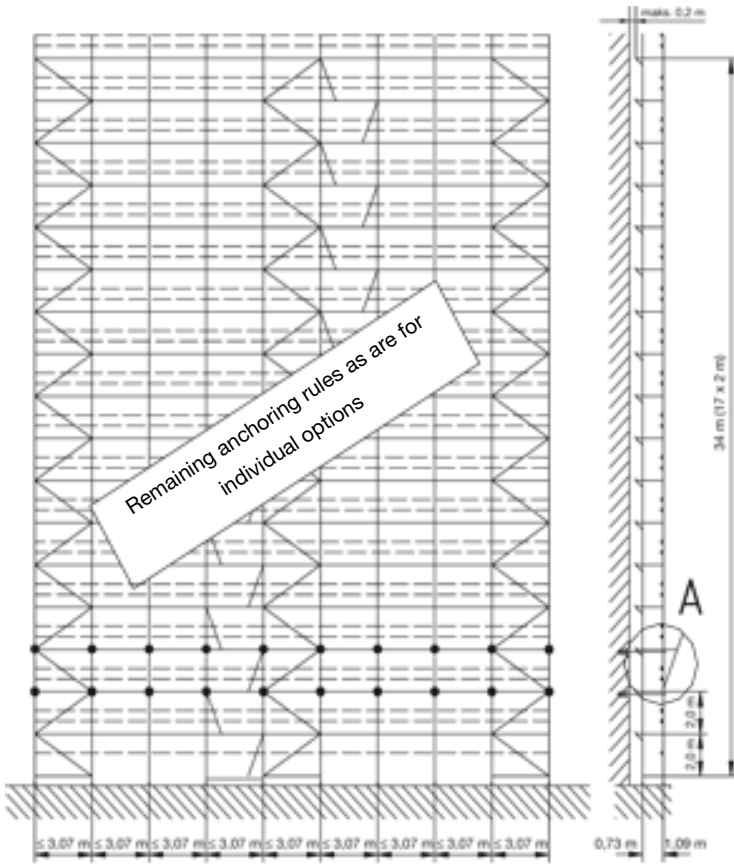

Fig. 2.35 – Forces present in anchor and in footings as are in individual options

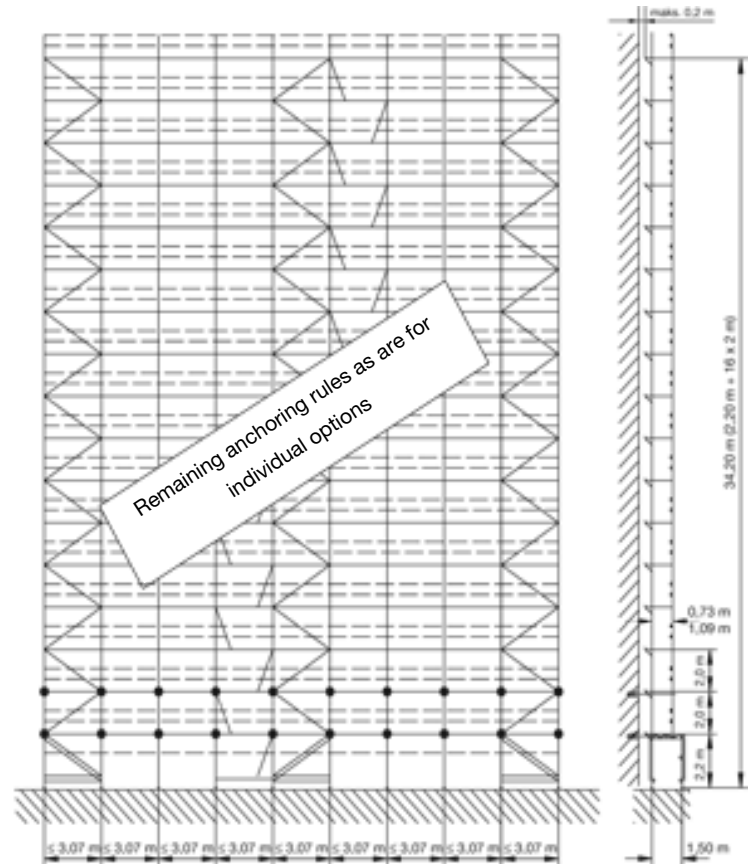

Fig. 2.36 – Forces present in anchor and in footings as are in individual options

Detail A

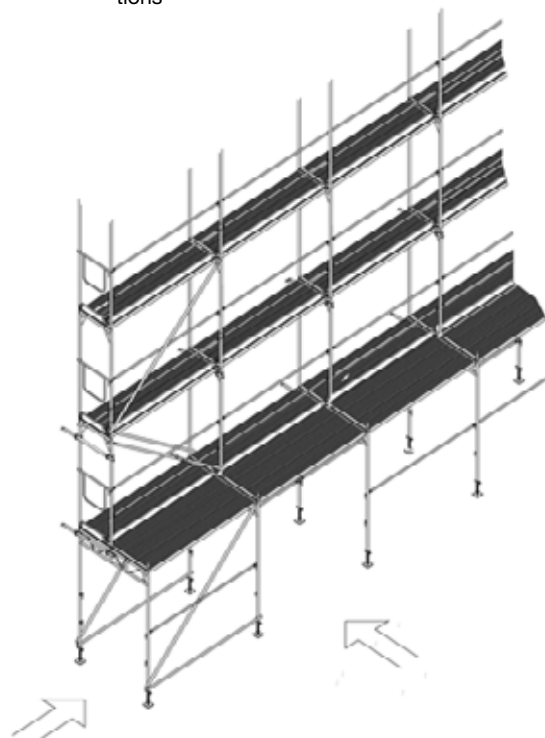
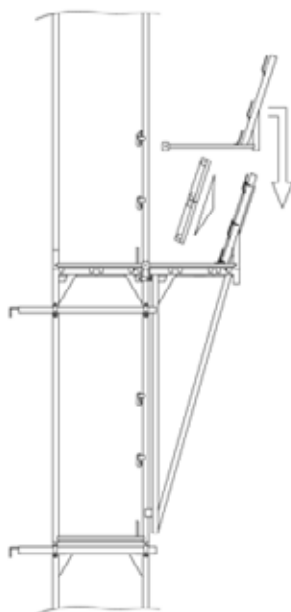

Fig. 2.11 – Protective canopy example

**WARNING:**

Assembly manual does not substitute OHS rules at the construction site!  
Construction manager is responsible for proper scaffolding assembly and inspection!



## 3. MOBILE SCAFFOLDINGS

### 3. Mobile scaffoldings

The featured system allows the creation of mobile scaffoldings based on elements used with facade set-up. Examples of this set-up are presented in the illustrations below.

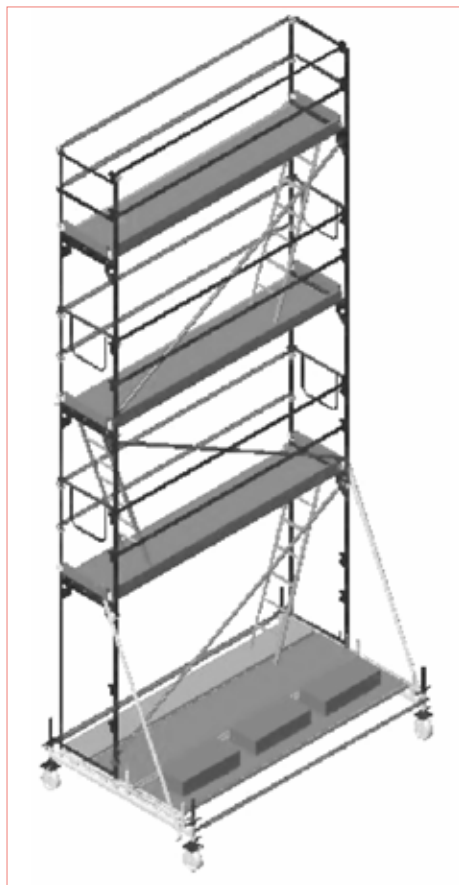

Fig. 3.1 – Set with a width of one frame



Fig. 3.2 – Set with a width of two frames

The following rule must be obeyed when building mobile scaffoldings: **scaffoldings height cannot exceed tripled length of the smaller side of scaffolding base**, in case of a scaffolding placed outside the building, and quadrupled length of smaller side of the scaffolding base in case of scaffolding placed inside the building. This rule does not apply to mobile scaffoldings anchored to the building.

Following rules must be obeyed during work on this type of scaffolding:

- work only on one work level,
- do not mount winches,
- move the scaffolding only across flat, even and strong enough surface,
- move only along the longer axis of the scaffolding,
- workers and tools are not allowed to be/remain on the scaffolding during moving,
- after the scaffolding reached its destination point, lock the castor brakes,
- after the scaffolding is moved, check its stability (all castors supporting the scaffolding).

#### **WARNING:**

*Assembly manual does not substitute OHS rules at the construction site!  
Construction manager is responsible for proper scaffolding assembly and inspection!*



## 4. GENERAL REQUIREMENTS AND SAFETY RULES FOR SCAFFOLDING ASSEMBLY AND USE

## 4. General requirements and safety rules during scaffolding assembly and use

The OHS general rules specific for this branch must be obeyed during scaffolding work.

**4.1.** All the workers hired for scaffolding assembly and disassembly should be trained for specific scaffolding assembly and be authorized by training centres approved by the Institute of Mechanised Construction and Rock Mining - Warsaw (Instytut Mechanizacji Budownictwa i Górnictwa Skalnego w Warszawie).

**4.2.** During assembly and disassembly of the scaffolding, danger zone must be established and secured with proper markings and railings placed at the minimum height of 1.5 m. Danger zone cannot be smaller than 1/10 of scaffolding height, and not less than 6 m. In dense city building, aforementioned zone can be made smaller, but also must follow procedures and rules based on Regulation of the Minister of Infrastructure (Journal of Laws No. 47/03, item 401).

**4.3.** Assembly, usage and disassembly of scaffoldings is forbidden during:

- a) sunset, if no proper lighting has been provided;
- b) heavy fog, rain, snow and glazed frost;
- c) storm and wind that exceeds 10 m/s.

**4.4.** When there is a risk of uninsulated cable touching the metal part of the scaffolding, then the overhead power lines must be shut down during scaffolding assembly, disassembly and usage. Overhead power lines do not need to be shut down when they are placed outside the danger zone. It is a minimum distance (horizontally) from closest swinging cables to the scaffolding and to farthest end of transported elements.

The distance is:

- a) 3 m for a powerline with maximum rated voltage of 1 kV;
- b) 5 m for a power line with rated voltage between 1 kV and 15 kV;
- c) 10 m for a power line with rated voltage between 15 kV and 30 kV;
- d) 15 m for a power line with rated voltage between 30 kV and 110 kV;
- e) 30 m for a power line with rated voltage above 110 kV.

**4.5.** Scaffolding lightning rods

Scaffolding structure should be equipped with lightning rods according to PN-M-47900-2:1996 section 4.8. "Lightning rods".

**4.6.** Scaffolding grounding

Each scaffolding structure must be grounded according to requirements of PN-M-47900-2:1996 section 4.8.3. "Grounding".

**4.7.** Cables

Live cables on the scaffolding, or near to it, must meet the requirements of PN-M-47900-2:1996 section 4.9.2. and 4.9.3.

**4.8.** Scaffolding usage is allowed after it has been accepted by construction manager or other qualified person. Scaffolding acceptance is confirmed with a log in a construction logbook or with commission protocol (Regulation of the Minister of Infrastructure § 110, Journal of Laws No. 47/03, item 401). Annex 1 is an example of Scaffolding Commission Protocol. Detailed acceptance procedure is described in the Regulation of the Minister of Infrastructure (Journal of Laws No. 47/03, item 401, § 110).

**4.9.** scaffolding load-bearing capabilities must be placed on information board attached to scaffolding. Loading the scaffolding with materials above its load-bearing capabilities as well as worker gatherings on platforms are forbidden.

**4.10.** Each scaffolding must be equipped with circulation paths. Circulation paths must be made simultaneously with scaffolding assembly. The spacing between neighbouring circulation paths cannot exceed 40 m. The distance from circulation path to furthest work place cannot exceed 20 m.

**4.11.** Scaffoldings made to be used in II and III wind zone must undergo additional analyses with static proof calculations for the wind (according to PN-77/B-02011). Static proof calculations establish the number of anchors for one sector of the scaffolding, assuming that the scaffolding breaking force (perpendicular to the wall) per one anchor cannot exceed 2.5 kN (250 kg).

**WARNING:**

*Assembly manual does not substitute OHS rules at the construction site!  
Construction manager is responsible for proper scaffolding assembly and inspection!*

## 4. GENERAL REQUIREMENTS AND SAFETY RULES FOR SCAFFOLDING ASSEMBLY AND USE



Fig. 4.1 – Wind load map according to PN-77/B-02011

**4.12.** All scaffolding pipe elements' connections must be made with standard and rotary coupling. Couplings must be screwed with screw tightening torque of 50 Nm.

**4.13.** Scaffolding must be placed on hardened basis. When placed on ground-base, use wooden pads (one pad for two footings).

**4.14.** Scaffolding disassembly can be performed after all the construction works (performed on the scaffolding) are finished and all working platforms, tools and materials are removed. Partial disassembly of the upper part (along work progress) is allowable. **It is forbidden during disassembly to cast down elements from heights.** After disassembly, all elements should be cleaned, checked and segregated if some need to be fixed or replaced.

**4.15.** Each scaffolding, after assembly at the user's site and before it is accepted, must undergo operational tests, according to PN-M-47900-2:1996 section 7.3. "Assembled scaffolding test at the user's site". The tests must be performed each time the works on the scaffolding are completed.

**4.16.** Load-bearing capability of anchor and base connection must be verified with tests. The number of tested anchors must be established by construction manager or scaffolding assembly supervisor, whereby the following rules must be obeyed:

- test load must equal 1.2 x required anchoring force established for each scaffolding option;
- number of tested anchorings must be at least:
  - 20% in case of concrete base
  - 40% in case of a base made of other materials
- all types of anchors must be tested;
- anchors are tested with a special device made for anchor and lever (1:10) testing. When load-bearing capability of peg and base connection does not guarantee the distribution of required anchoring forces, use triangular anchors in the same anchoring spot, or rise the number of anchors.

**4.17.** Permissible scaffolding load is 2 kN/m<sup>2</sup> (200 kg/m<sup>2</sup>). Scaffolding user is obliged to post up an information board that contains aforementioned load level.

### WARNING:

*Assembly manual does not substitute OHS rules at the construction site!  
Construction manager is responsible for proper scaffolding assembly and inspection!*

4. GENERAL REQUIREMENTS AND SAFETY RULES FOR SCAFFOLDING ASSEMBLY AND USE

4.18. When placing loads on the scaffolding platforms, the following guidelines and rules must be obeyed:

- a) actual working weight on the platform consists of total value of individual weights on different spaces. Thus, it is important to avoid accumulating loads in one area of the scaffolding (in case of steel and wooden platforms);
- b) platform load must be placed evenly on its entire surface;
- c) each worker is an equivalent of 0.8 kN (80 kg);
- d) when there is an element with certain weight being delivered with a hoist onto scaffolding, then the weight of the element needed for platform load calculation must be increased with modulus 1.2;
- e) avoid dynamic loads on the platform, e.g. jumping, throwing weights, etc.;
- f) platforms mounted on brackets must be in the same load group as standard scaffolding platforms.

4.19. Scaffolds placed adjacent to public roads should have protective canopies attached (drop directed at the building, at the angle of 45 degrees)°. Distance between the canopy and the ground in the lowest point cannot be smaller than 2.4 m. Protective canopies over passages and crossings must be tight and made of planks with minimum thickness of 24 mm. Canopies must be covered with shock-absorption material that protects against falling objects. Canopy should be at least 1 m wider than the passage or crossing. It should touch the building wall.

Protective canopy radius should equal (measuring from external raw of stands, for the following scaffolding heights):

- up to 20 m – min. 2.2 m,
- up to 20 m – min. 3.5 m.

Stands supporting the canopy structures must be distanced from the curbs by minimum 0.8 m.

4.20. Frames placed near gates, clearances and crossings with car traffic, must be secured with roll-stops not connected to scaffolding structure.

4.21. The area, where assembly and disassembly works takes place, must be marked with visibly placed information boards mounted at the height of 2.5 m measuring from the ground level. Signs on the boards must be visible from a distance of at least 10 m.

4.22. If a crossing was rendered inactive during scaffolding assembly (with proper permission from territorial authority), a barrier must be placed at the crossing and a red information board with a warning sign about the crossing being inactive. Red light must be placed at the barrier during night.

4.23. When using scaffolding during winter, or during heavy snow – remove the snow from scaffolding before proceeding with work.

4.24. The user is not allowed to make changes to scaffolding structure without the assembly contractor's permission. This applies in particular to: partial anchor disassembly as well as canvas, net screens and billboards installation.

4.25. The rules for scaffoldings, measuring maximum height of H= 34 m, introduced in this manual are applicable to scaffoldings longer than 10 m. Scaffolding, which length is smaller than 10 m, or which height exceeds 34 m must be perceived as non-standard. Thus, additional static proof calculations are required.

4.26. Scaffolding inspections during usage

- **Daily inspections**

Daily inspections should be performed by scaffolding users.

Daily inspection verifies whether:

- scaffolding is properly anchored and was not damaged or deformed,
- cables are properly isolated,
- the condition of safety and working platform's surfaces is proper (platform cleanliness, anti-slip platform – protection during winter),
- other safety decreasing phenomena occurred on the scaffolding.

**WARNING:**

*Assembly manual does not substitute OHS rules at the construction site!  
Construction manager is responsible for proper scaffolding assembly and inspection!*

## 4. GENERAL REQUIREMENTS AND SAFETY RULES FOR SCAFFOLDING ASSEMBLY AND USE

- **Decade inspections**

Decade inspections should be performed every 10 days by engineering/technician worker assigned by construction management. Decade inspection checks the scaffolding for structural changes that may cause construction disaster or create hazardous conditions during scaffolding usage.

In particular, check whether:

- the scaffolding was not undermined,
- anchors were not damaged,
- canopies are tight and undamaged,
- lightning rods and grounding was not damaged,
- working platforms are secured with railings and curbs.

- **Ad hoc inspections**

Ad-hoc inspections should be performed after usage discontinuity longer than 2 weeks, and after force 6 winds (12 m/s). Ad-hoc inspection should be performed by a committee consisting of master, foreman and building control inspector. Ad-hoc inspections can be organized at any time by Social Labour Inspectorate and building control bodies. Faults spotted during each inspection must be removed before commencing further scaffolding usage. Construction manager (or a person authorized by him) is responsible for inspection execution. Decade and ad-hoc inspection results must be noted down in logbook by the inspecting personnel.

**WARNING:**

*Assembly manual does not substitute OHS rules at the construction site!  
Construction manager is responsible for proper scaffolding assembly and inspection!*



5. Exemplary, non-standard scaffolding anchorings

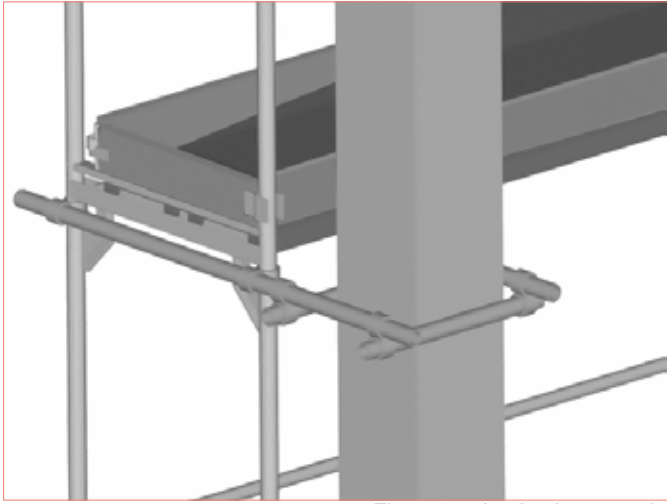

Fig. 5.1 – Anchoring to pole

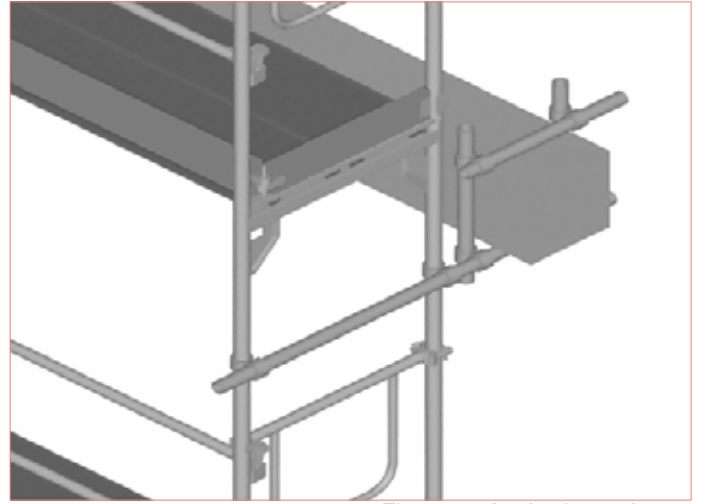

Fig. 5.2 – Anchoring to beam

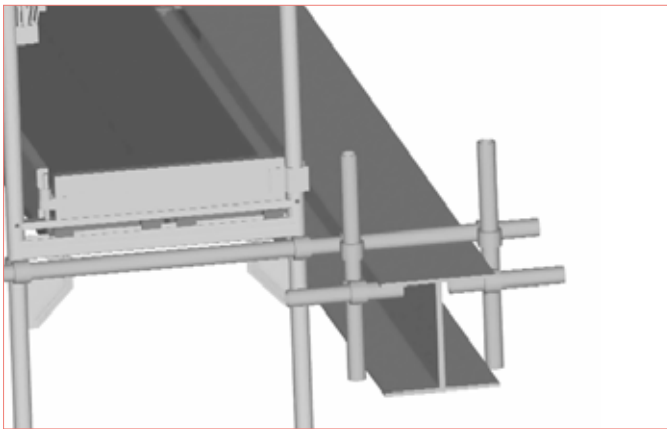

Fig. 5.3 – Anchoring to I-beam

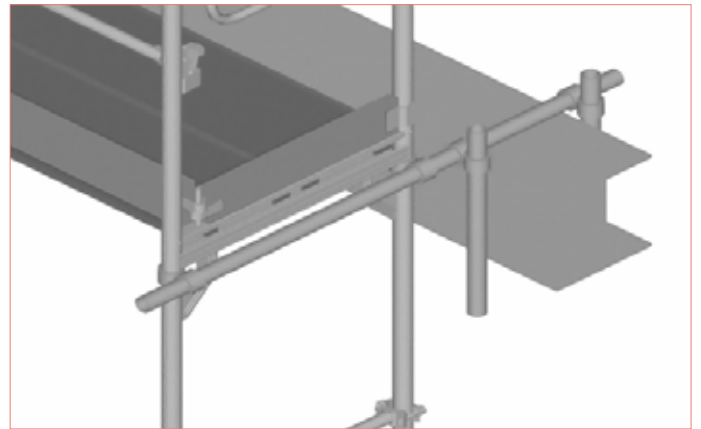

Fig. 5.4 – Anchoring to I-beam

**WARNING:**

*Assembly manual does not substitute OHS rules at the construction site!  
Construction manager is responsible for proper scaffolding assembly and inspection!*

## 6. FRAME SCAFFOLDINGS SET-UP EXAMPLES

### 6. Exemplary frame scaffolding set-ups

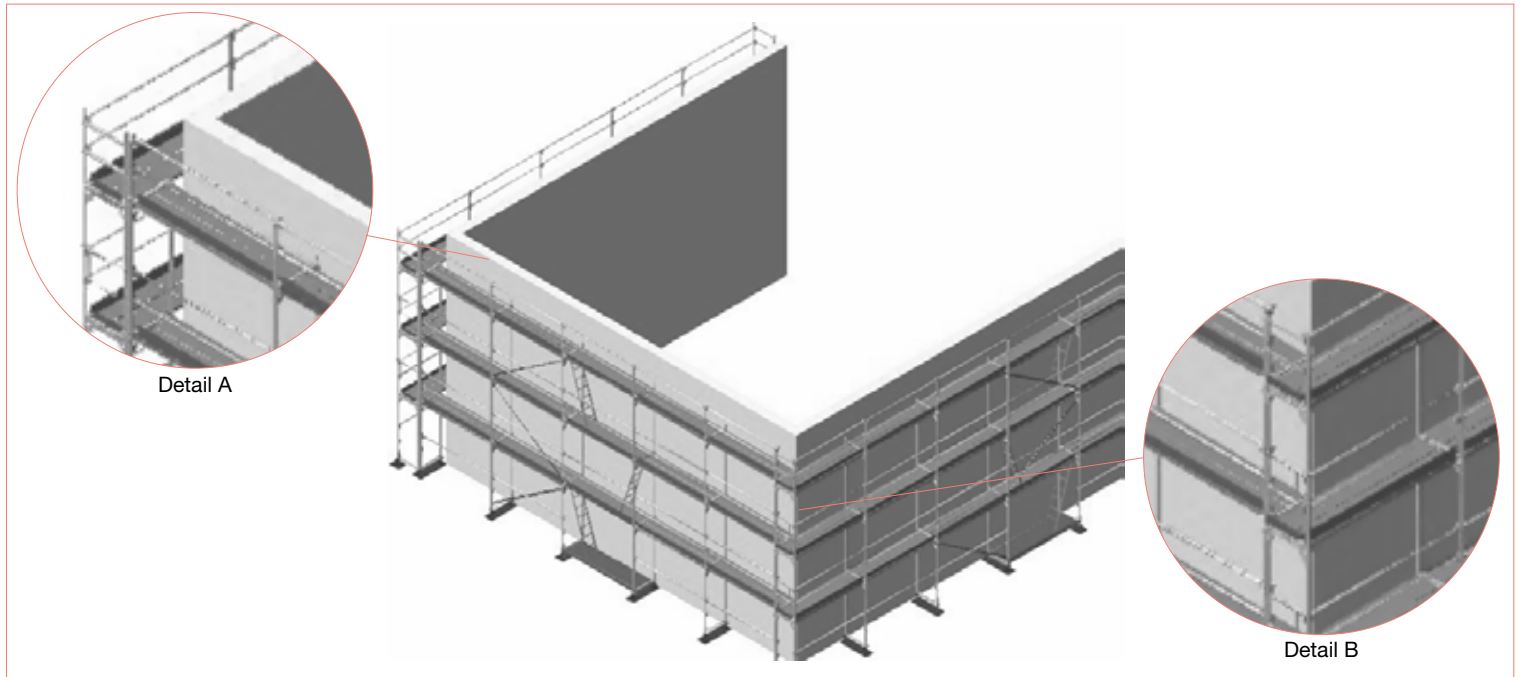

Fig. 6.1 – Wall set-up

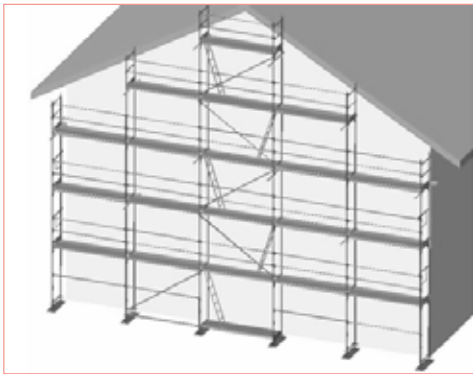

Fig. 6.2 – Gable set-up

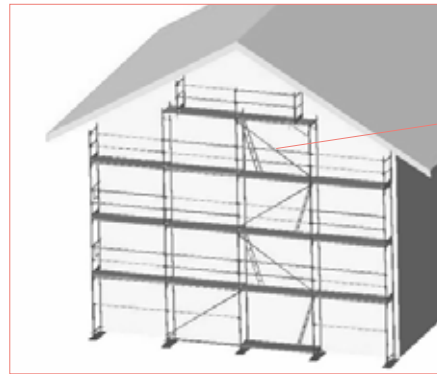

Fig. 6.3 – Gable set-up with bay shortened from 3.07 m to 2.57 m with the use of e285550 bracket

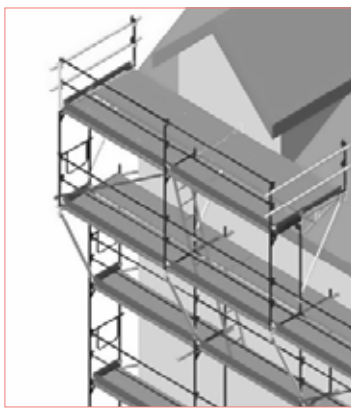

Fig. 6.4 – Dormer window execution 1

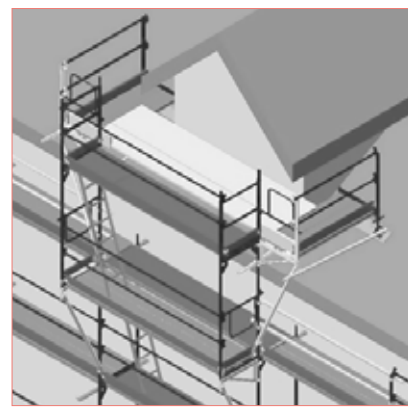

Fig. 6.5 – Dormer window execution 2

#### **WARNING:**

*Assembly manual does not substitute OHS rules at the construction site!  
Construction manager is responsible for proper scaffolding assembly and inspection!*

## 7. Data required to perform structural analysis for scaffoldings

### 7.1. Execution – general information

All scaffoldings must be assembled in accordance to the rules described in assembly manual, and to standards and legal regulations appropriate for this branch.

### 7.2. General data

In case of standard set-ups, stability can be considered verified if a scaffolding set-up matches the set-up presented in this manual. Standard set-ups are described in chapter 2 (page 18 – 35).

### 7.3. Non-standard scaffolding set-ups

In case of non-standard set-ups, static proof calculations are required. Foundations and data needed for calculations are presented in separate paper and are available at request.

**WARNING:**

*Assembly manual does not substitute OHS rules at the construction site!  
Construction manager is responsible for proper scaffolding assembly and inspection!*



## 8. ELEMENTS' CONSTRUCTION MATERIALS

### 8. Raw - materials used for elements' construction

All the information concerning the shape and parameters of materials used during scaffolding elements' production, are presented in the scaffolding elements' illustrations and can be acquired at manufacturer's site. Basic material for primary scaffolding elements is S235JRG2 steel with raised ductility limit  $R_e \geq 320$  MPa (for frame structure elements) or, respectively  $R_e \geq 280$  MPa (for platforms), in secondary elements – steel  $R_e \geq 235$  MPa.

**WARNING:**

*Assembly manual does not substitute OHS rules at the construction site!  
Construction manager is responsible for proper scaffolding assembly and inspection!*

## 9. Product marking system

All products made by ALTRAD-Mostostal are certified with ISO 9001. The indicating markings are in the form of permanent imprints 0.7 mm deep and are placed in the areas indicated in technical specification. Additionally, manufacturer and/or client stickers are placed according to individual agreement.

### Element marking – cold work mark punch

**A 75 XYY** – general structure of the mark

A 75 – fixed mark for ALTRAD-Mostostal in Siedlce

X – letter designation for month (changeable mark)

YY – numerical designation for year (changeable mark)









Month symbol - X -		Year symbol - YY -	
A – January	G – July	01 = 1995	07 = 2001
B – February	H – August	02 = 1996	08 = 2002
C – March	I – September	03 = 1997	09 = 2003
D – April	J – October	04 = 1998	10 = 2004
E – May	K – November	05 = 1999	.....
F – June	L – December	06 = 2000	95 = 2099

Additionally, it is possible to punch a mark supplemented with a product acceptance certificate number for domestic markets, e.g. Ü 190, Ü 846, Ü 886, Ü 887. Additional marking is placed at the end of basic marking. Mark placement is specified on products design drawings.

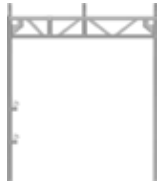

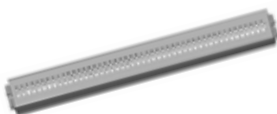



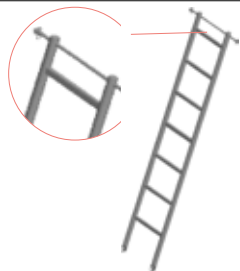

**WARNING:**

*Assembly manual does not substitute OHS rules at the construction site!  
Construction manager is responsible for proper scaffolding assembly and inspection!*

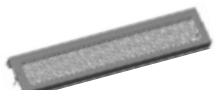
## 10. INDEX OF FRAME SCAFFOLDING'S ELEMENTS









Element name	Index	Weight	
Steel frame Plus 0.73 x 2.0 m	e202026	19.7	
Steel frame Plus 0.73 x 1.5 m	e202027	16.1	
Steel frame Plus 0.73 x 1.0 m	e202028	13.0	
Steel frame Plus 0.73 x 0.6 m	e202029	10.2	
Aluminium frame 0.73 x 2.0 m	e203012	9.8	
			
Bypass frame 0.73 x 2.0 m	e202019	25.1	
Steel frame Plus 0.36 x 2.0 m	e202018	17.8	
			
Passage frame 1.5 x 2.2 m	e202195	35.8	
Passage frame 1.75 x 2.2 m	e202197	39.0	
			
Steel plank 0.32 x 0.73 m – U	e491307	6.0	
Steel plank 0.32 x 1.09 m – U	e491310	8.5	
Steel plank 0.32 x 1.57 m – U	e491315	11.7	
Steel plank 0.32 x 2.07 m – U	e491320	15.1	
Steel plank 0.32 x 2.57 m – U	e491325	18.5	
Steel plank 0.32 x 3.07 m – U	e491330	21.9	
Steel plank 0.32 x 0.73 m – U	e491307c	5.8	
Steel plank 0.32 x 1.09 m – U	e491310c	8.0	
Steel plank 0.32 x 1.57 m – U	e491315c	11.1	
Steel plank 0.32 x 2.07 m – U	e491320c	14.2	
Steel plank 0.32 x 2.57 m – U	e491325c	17.4	
Steel plank 0.32 x 3.07 m – U	e491330c	20.5	
Steel plank 0.32 x 1.57 m – U	e491415	12.1	
Steel plank 0.32 x 2.07 m – U	e491420	15.5	
Steel plank 0.32 x 2.57 m – U	e491425	18.9	
Steel plank 0.32 x 3.07 m – U	e491430	22.2	
Steel plank 0.32 x 4.14 m – U	e491440	29.6	
Steel plank 0.32 x 0.73 m – U	e491607	6.4	
Steel plank 0.32 x 1.09 m – U	e491610	8.5	
Steel plank 0.32 x 1.57 m – U	e491615	11.2	
Steel plank 0.32 x 2.07 m – U	e491620	14.0	
Steel plank 0.32 x 2.57 m – U	e491625	15.9	
Steel plank 0.32 x 3.07 m – U	e491630	18.5	
			
Steel plank 0.19 x 0.73 m – U	e491807	4.6	
Steel plank 0.19 x 1.09 m – U	e491810	6.5	
Steel plank 0.19 x 1.57 m – U	e491815	9.0	
Steel plank 0.19 x 2.07 m – U	e491820	11.6	
Steel plank 0.19 x 2.57 m – U	e491825	14.3	
Steel plank 0.19 x 3.07 m – U	e491830	16.9	
			
Alu-plywood platform 0.61 x 1.09 m	e491110	10.7	
Alu-plywood platform 0.61 x 1.57 m	e491115	13.8	
Alu-plywood platform 0.61 x 2.07 m	e491120	17.0	
Alu-plywood platform 0.61 x 2.57 m	e491125	19.9	
Alu-plywood platform 0.61 x 3.07 m	e491130	23.0	
			
Alu. platform with ladder 0.61 x 2.57 m	e492325	26.8	
Alu. platform with ladder 0.61 x 3.07 m	e492330	29.7	
			
Pass-by alu. platform 0.61 x 1.57 m – U	e492515	16.2	
Pass-by alu. platform 0.61 x 2.07 m – U	e492520	19.4	
Pass-by alu. platform 0.61 x 2.57 m – U	e492525	22.3	
Pass-by alu. platform 0.61 x 3.07 m – U	e492530	25.2	
Pass-by alu. platform 0.61 x 2.07 m – O	e492620	20.3	
Pass-by alu. platform 0.61 x 2.57 m – O	e492625	28.1	
Pass-by alu. platform 0.61 x 3.07 m – O	e492630	31.0	

10. INDEX OF FRAME SCAFFOLDINGS ELEMENTS





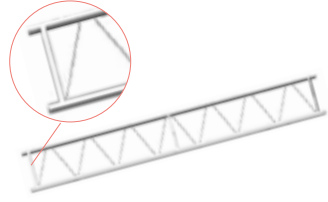





Element name	Index	Weight	
Aluminium ladder (for platforms e4925....)	e492600	4.26	
Ladder's bolt	e492603	0.3	
Inter-storey ladder 0.32 x 2.14 m	e511600	11.1	
Steel plank 0.3 x 1.5 m	e494015	9.9	
Steel plank 0.3 x 2.0 m	e494020	12.9	
Steel plank 0.3 x 2.5 m	e494025	16.0	
Steel plank 0.3 x 3.0 m	e494030	19.0	
Steel plank 0.3 x 1.0 with protection	e494110	7.0	
Steel plank 0.3 x 1.5 with protection	e494115	10.0	
Steel plank 0.3 x 2.0 with protection	e494120	13.0	
Steel plank 0.19 x 1.0 with protection	e494210	5.2	
Steel plank 0.19 x 1.5 with protection	e494215	7.6	
Steel plank 0.19 x 2.0 with protection	e494220	10.1	
Standard steel footing	e511200	1.3	
Base jack 0.4 m	e511204	3.4	
Base jack 0.6 m	e511206	4.4	
Base jack 0.8 m	e511208	5.3	
Base jack 1.5 m	e511313	9.8	
Tilt base jack 0.8 m	e511408	7.9	
Tilt base jack 1.1 m	e511411	9.5	
Front-end railing 0.73 m	e283907	3.7	
Front-end railing 1.09 m	e283910	4.6	
Front-end railing 0.73 m (with wedge)	e283007	3.8	
Front-end railing 1.09 m (with wedge)	e283010	4.8	
Single railing 0.73 m	e283607	1.5	
Single railing 1.09 m	e283610	2.1	
Single railing 1.57 m	e283615	3.0	
Single railing 2.07 m	e283620	3.8	
Single railing 2.57 m	e283625	4.7	
Single railing 3.07 m	e283630	5.5	
Double railing 1.57 m	e284215	7.3	
Double railing 2.07 m	e284220	9.1	
Double railing 2.57 m	e284225	11.4	
Double railing 3.07 m	e284230	13.2	
Double railing 4.14 m	e284240	17.6	
Double alu. railing 1.09 m	e284310	2.7	
Double alu. railing 1.57 m	e284315	3.9	
Double alu. railing 2.07 m	e284320	4.8	
Double alu. railing 2.57 m	e284325	5.8	
Double alu. railing 3.07 m	e284330	6.7	
Railing post H – 1.0 m; t – 3.2 mm	e202085	5.4	
Railing post 0.73 x 1.0 m; t – 2.7 mm	e202089	6.5	
Railing post 0.73 x 1.0 m; t – 2.7 mm	e202091	5.8	
Railing post 1.09 x 1.0 m; t – 2.7 mm	e202092	6.5	
Alu. railing post 0.73 x 1.0 m	e203083	3.3	
Alu. railing post H – 1.0 m	e203084	2.8	





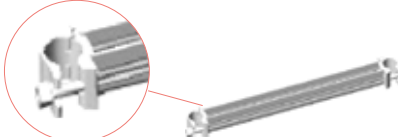

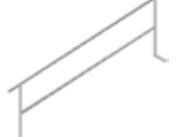











## 10. INDEX OF FRAME SCAFFOLDINGS ELEMENTS

Element name	Index	Weight	
Front-end frame 0.73 x 1.0 m; t – 2.7 mm	e202023	11.3	
Front-end frame 1.09 x 1.0 m; t – 2.7 mm	e202024	13.2	
Light, steel front-end frame 0.73 x 1.0 m; t – 2.7 mm (with pilot)	e203023	12.7	
Alu. front-end frame 0.73 x 1.0 m (without pilot)	e203080	6.1	
Angle brace 2.0 x 1.57 m	e284715	5.8	
Angle brace 2.0 x 2.07 m	e284720	6.6	
Angle brace 2.0 x 2.57 m	e284725	7.4	
Angle brace 2.0 x 3.07 m	e284730	8.3	
Angle brace 2.0 x 1.57 m (with wedge)	e284815	5.9	
Angle brace 2.0 x 2.07 m (with wedge)	e284820	6.8	
Angle brace 2.0 x 2.57 m (with wedge)	e284825	7.6	
Angle brace 2.0 x 3.07 m (with wedge)	e284830	8.5	
Transverse curb 0.73 m	e286807	1.7	
Transverse curb 1.09 m	e286810	2.4	
Longitudinal curb 1.09 m	e286813	3.0	
Longitudinal curb 1.57 m	e286815	4.2	
Longitudinal curb 2.07 m	e286820	5.4	
Longitudinal curb 2.57 m	e286825	6.7	
Longitudinal curb 3.07 m	e286830	7.9	
Horizontal brace 2.07 m	e283820	9.2	
Horizontal brace 2.57 m	e283825	11.1	
Horizontal brace 3.07 m	e283830	13.0	
Net screen 1.57 m	e285015	16.5	
Net screen 2.07 m	e285020	20.1	
Net screen 2.57 m	e285025	23.7	
Net screen 3.07 m	e285030	27.4	
Net screen post 0.73 m	e285907	14.9	
Net screen post 1.09 m	e285910	16.5	
Protective roof bracket 0.73 m	e288501	6.0	
Lattice alu. girder 0.4 x 3.0 m	e501230	12.7	
Lattice alu. girder 0.4 x 4.0 m	e501240	17.0	
Lattice alu. girder 0.4 x 5.24 m	e501252	20.9	
Lattice alu. girder 0.4 x 6.0 m	e501260	24.7	
Lattice alu. girder 0.4 x 6.24 m	e501262	25.1	
Lattice alu. girder 0.4 x 8.0 m	e501280	33.2	
Lattice alu. girder 0.5 x 3.24 m	e501330	14.9	
Lattice alu. girder 0.5 x 4.24 m	e501340	18.8	
Lattice alu. girder 0.5 x 5.24 m	e501350	22.6	
Lattice alu. girder 0.5 x 6.24 m	e501360	26.4	
Lattice alu. girder 0.4 x 2.0 m	e503320	21.1	
Lattice steel girder 0.4 x 3.0 m	e503330	30.6	
Lattice steel girder 0.4 x 4.0 m	e503340	41.3	
Lattice steel girder 0.4 x 6.0 m	e503360	60.3	
Lattice steel girder 0.5 x 3.24 m	e503230	36.4	
Lattice steel girder 0.5 x 4.24 m	e503240	45.6	
Lattice steel girder 0.5 x 5.24 m	e503250	54.8	
Lattice steel girder 0.5 x 6.24 m	e503260	64.8	
Lattice steel girder 0.4 x 5.14 m	e287754	56.0	
Lattice steel girder 0.4 x 6.14 m	e287761	62.6	
Pass-by, steel girder 0.4 x 6.14 m –	e287762	62.1	
Lattice steel girder 0.4 m (short)	e502140	8.7	

10. INDEX OF FRAME SCAFFOLDINGS ELEMENTS

Element name	Index	Weight	
Lattice steel girder 0.4 m (long)	e502240	30.19	
Girder coupling link with fasteners L = 0.4 m	e502000	2.2	
Alu. crosshead 0.6 m	e501006	2.7	
Alu. crosshead 0.9 m	e501009	3.3	
Alu. crosshead 1.2 m	e501012	3.8	
Alu. crosshead 1.6 m	e501016	5.2	
Alu. crosshead 1.9 m	e501019	5.8	
Alu. crosshead 3.0 m	e501030	8.5	
Alu. crosshead 4.0 m	e501040	10.2	
Alu. crosshead 5.0 m	e501050	12.7	
Alu. crosshead 6.0 m	e501060	15.2	
Girder's transom 0.73 m	e503573	7.4	
Pass-by girder transom 0.73 m	e503407	2.8	
Alu. stairs 2.57 m	e286225	25.1	
Alu. stairs 3.07 m	e286230	29.9	
Stairs Primary U-transom 0.73 m	e286207	3.0	
Transverse transom 0.73 m	e285379	3.3	
Transverse transom 1.09 m	e285319	6.0	
Stairs' external railing 2.57 m	e286325	16.0	
Stairs' external railing 3.07 m	e286330	17.8	
Stairs' internal railing 2.0 x 3.0 m	e286300	12.8	
Wall tie 0.4 m	e286504	1.6	
Wall tie 0.5 m	e286505	1.9	
Wall tie 0.8 m	e286508	2.9	
Wall tie 1.1 m	e286511	3.9	
Wall tie 1.3 m	e286513	4.5	
Wall tie 1.5 m	e286515	5.2	
Wall tie 1.9 m	e286519	6.5	

## 10. INDEX OF FRAME SCAFFOLDINGS ELEMENTS

Element name	Index	Weight	
Bracket with clamp 0.36 m	e285539	3.4	
Bracket with clamp 0.50 m	e285550	4.9	
Bracket with clamp 0.73 m	e285579	6.3	
Bracket with clamp 1.09 m	e285519	10.4	
Bracket with clamp 0.73 m (high)	e285589	19.5	
Diagonal 1.77 m	e285179	8.2	
Diagonal 1.95 m	e285119	8.8	
Bracket platform protection 0.36 m	e285403	0.9	
Bracket platform protection 0.73 m	e285407	1.7	
Bracket platform protection 1.09 m	e285410	2.4	
Alu. overpass 4.25 m	e491042	32.7	
Alu. overpass 5.2 m	e491052	39.0	
Alu. overpass 6.1 m	e491061	46.0	
Alu. overpass 7.1 m	e491071	52.5	
Alu. post for railing	e491001	2.5	
Railing clamp	e491002	0.3	
Clamp for alu. gang-board.	e491003	0.3	
Transport beam	e571173	26.3	
Footing with two nuts	e571175	4.1	
Castor Ø 200 mm	MP-116	4.6	
Anchor eye-bolt 0.12 m	e511012	0.2	
Anchor eye-bolt 0.19 m	e511019	0.3	
Anchor eye-bolt 0.23 m	e511023	0.4	
Normal coupling	e581119	0.8	
Rotary coupling	e581319	1.9	
Anchor coupling	e284610	0.9	
In-line coupling	e581419	1.5	
Assembly post	e206600	6.3	
Telescopic railing 1.5 m – 2.07 m	e206800	3.45	
Telescopic railing 2.07 m – 3.7 m	e206700	4.23	

11. Exemplary set – frame scaffolding

Presented below are basic, frame scaffolding set-up and exemplary indexes of individual elements (element index: see page 46 – 50).

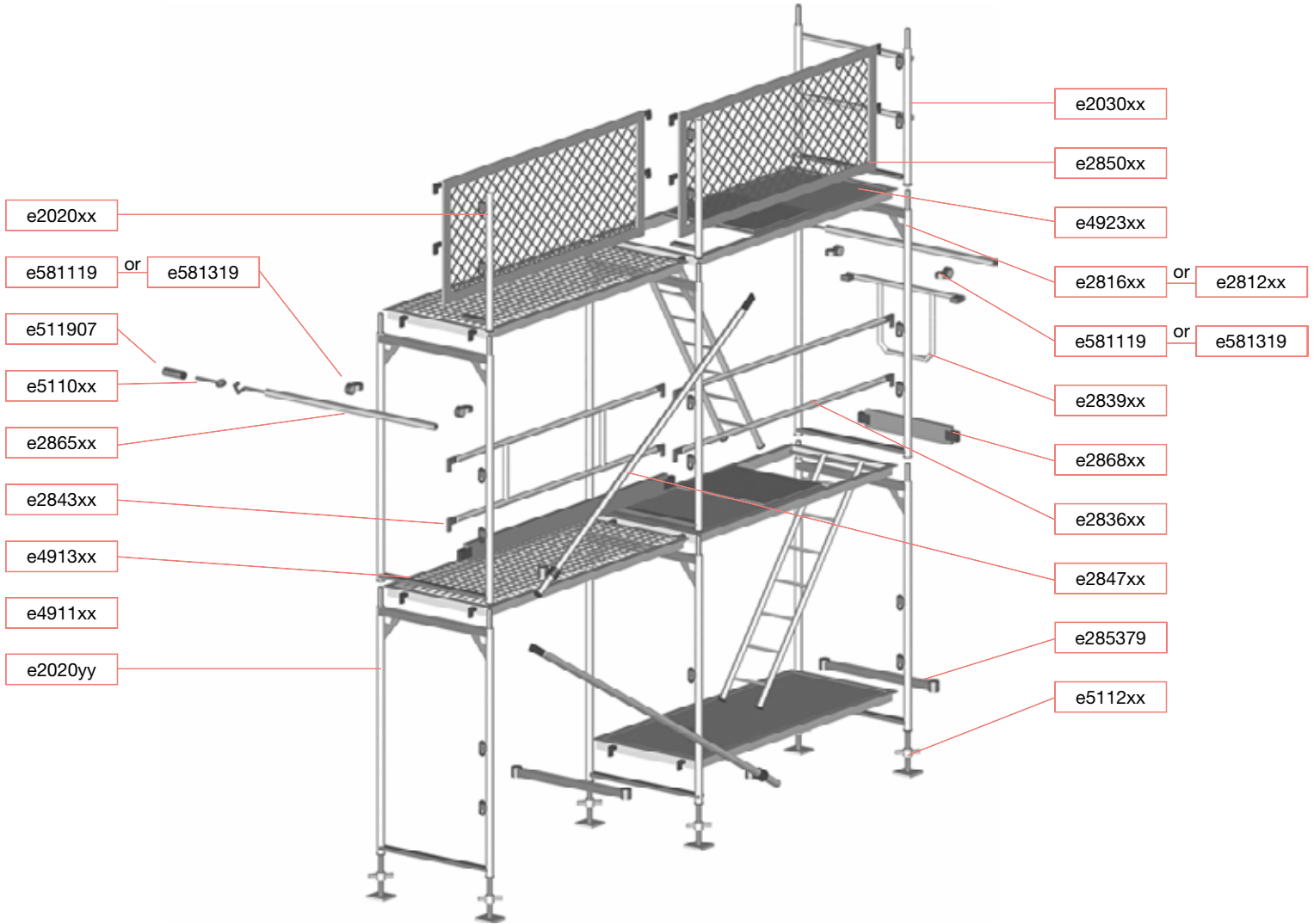



**SCAFFOLDING COMMISSION PROTOCOL**

1. Protocol reg. no .....
2. Scaffolding acceptance date .....
3. Scaffolding assembly contractor ..... tel. ....
4. Scaffolding user (Assembly Ordering Party) .....
5. Scaffolding technical overview:
  - type/model .....
  - scaffolding parameters .....
  - place of assembly .....
  - working platforms' permissible load .....
  - special equipment .....
  - ground's resistance (grounding) .....
  - dates for subsequent scaffolding inspections .....
  - scaffolding's use .....

**DECLARATION AND CONFIRMATION**

6. Assembly Contractor certifies that the scaffolding described in this protocol is complete.  
The scaffolding was assembled with accordance to the rules of building and assembly manual provided by the manufacturer, as well as to the rules of OHS. The assembly was performed by certified fitters.
7. With this protocol, the assembly Contractor delivers as follows:
  - a) scaffolding scheme
  - b) scaffolding assembly manual
  - c) .....
  - d) .....
8. Scaffolding user accepts the scaffolding for exploitation without reservation and declares that is aware of the rules of use resulting from the assembly manual instructions.
9. Commission composed of below mentioned, confirms the scaffolding hand-over after assembly and acceptance for usage.
10. Commission members:
 

a) .....	.....	.....	– User
b) .....	.....	.....	– User
c) .....	.....	.....	– Contractor
Name	position	signature	

Application date for scaffolding disassembly:.....

Changes in scaffolding structure can only be performed by assembly Contractor.

When using the scaffolding, check its technical condition and completeness.





**ALTRAD-Mostostal Spółka z o.o.**

ul. Starzyńskiego 1, 08-110 Siedlce

tel. +48 25 644 82 93, fax +48 25 644 62 62

www.altrad-mostostal.pl, e-mail: handlowy@altrad-mostostal.pl

tel. 0 801 ALTRAD (0 801 25 87 23)

## **ALTRAD-Mostostal – SCAFFOLDING AND FORMWORK INDUSTRY LEADER**

- design
- production
- sale

### **SCAFFOLDINGS**

- frame
- ROTAX modular
- MP mobile

### **FORMWORKS**

- wall: MIDI BOX and MIDI BOX Plus
- ceiling: ALUstrop, standard ceiling system

and building accessories

**CALL US – ORDER  
THE SET  
THAT SUITS YOU BEST!**



ALTRAD-Mostostal Spółka z o.o.  
tel.: 0 801 ALTRAD (0 801 2 5 8 7 2 3)  
tel.: +48 25 644 82 93, fax: +48 25 644 62 62  
ul. Starzyńskiego 1, 08-110 Siedlce

[www.altrad-mostostal.pl](http://www.altrad-mostostal.pl)